



INSTRUCTION MANUAL

VHF MARINE TRANSCEIVER IC-M502

This device complies with Part 15 of the FCC rules. Operation is subject to the following two conditions: (1) This device may not cause harmful interference, and (2) this device must accept any interference received, including interference that may cause undesired operation.



Icom Inc.

IMPORTANT

READ ALL INSTRUCTIONS carefully and completely before using the transceiver.

SAVE THIS INSTRUCTION MANUAL — This instruction manual contains important operating instructions for the IC-M502.

IN CASE OF EMERGENCY

If your vessel requires assistance, contact other vessels and the Coast Guard by sending a distress call on channel 16.

Or, transmit your distress call using digital selective calling on channel 70.

USING CHANNEL 16

DISTRESS CALL PROCEDURE

1. "MAYDAY MAYDAY MAYDAY."
2. "THIS IS" (name of vessel)
3. Your call sign or other indication of the vessel (AND 9-digit DSC ID if you have one).
4. "LOCATED AT" (your position)
5. The kind of the distress and assistance required.
6. Any other information which might facilitate the rescue.

USING DIGITAL SELECTIVE CALLING (Ch 70)

DISTRESS CALL PROCEDURE

1. While lifting up the switch cover, push and hold [DISTRESS] for 5 sec. until you hear 5 short beeps change to one long beep.
2. Wait for an acknowledgment from a coast station.
 - Channel 16 is automatically selected.
3. Push and hold [PTT], then transmit the appropriate information as at left.

TABLE OF CONTENTS

IMPORTANT	i	■ Position and time programming	14	12 SPECIFICATIONS AND	
IN CASE OF EMERGENCY	i	■ Position indication	15	OPTIONS	42–43
TABLE OF CONTENTS	ii	■ Distress call	16	■ Specifications	42
CAUTIONS	iii	■ Transmitting DSC calls	17	■ Options	43
1 OPERATING RULES	1	■ Setting the distress information	21	13 HM-127 REMOTE-CONTROL	
2 PANEL DESCRIPTION	2–5	■ DSC individual ID	22	MICROPHONE	44–56
■ Panel description	2	■ Receiving DSC calls	23	■ Panel description	44
■ Function display	4	■ DSC set mode	26	■ Function display	46
■ Microphone	5	■ Receive messages	28	■ HM-127 supplied accessories	47
3 BASIC OPERATION	6–10	7 INTERCOM OPERATION	29	■ Installation	48
■ Channel selection	6	■ Intercom operation	29	■ Channel selection	50
■ Microphone lock function	7	8 SET MODE	30–33	■ Receiving and transmitting	51
■ Receiving and transmitting	8	■ Set mode programming	30	■ RF attenuator function	51
■ Call channel programming	9	■ Set mode items	31	■ Lock functions	52
■ Channel names	9	9 CONNECTIONS AND		■ Display backlighting	52
■ Optional voice scrambler		MAINTENANCE	34–39	■ Monitor function	52
operation	10	■ Supplied accessories	34	■ Call channel programming	53
4 DUALWATCH/TRI-WATCH	11	■ Antenna	34	■ Optional voice scrambler	
■ Description	11	■ Fuse replacement	34	operation	53
■ Operation	11	■ Cleaning	34	■ Starting a scan	54
5 SCAN OPERATIONS	12–13	■ Connections	35	■ Setting tag channels	54
■ Scan types	12	■ Mounting the transceiver	36	■ Dualwatch/Tri-watch operation	54
■ Setting tag channels	13	■ Optional unit installation	38	■ Set mode programming	55
■ Starting a scan	13	■ Dimensions.....	39	■ Intercom operation	56
6 DSC OPERATION	14–28	10 TROUBLESHOOTING	40	■ Channel names	56
■ MMSI code programming	14	11 CHANNEL LIST	41	TEMPLATE	

CAUTIONS

⚠ WARNING! NEVER connect the transceiver to an AC outlet. This may pose a fire hazard or result in an electric shock.

CAUTION: Changes or modifications to this device, not expressly approved by Icom Inc., could void your authority to operate this device under FCC regulations.

NEVER connect the transceiver to a power source of more than 16 V DC or use reverse polarity. This will ruin the transceiver.

NEVER cut the DC power cable between the DC plug and fuse holder. If an incorrect connection is made after cutting, the transceiver may be damaged.

NEVER place the transceiver where normal operation of the vehicle may be hindered or where it could cause bodily injury.

KEEP the transceiver at least 3.3 ft (1 m) away from the ship's navigation compass.

DO NOT use or place the transceiver in areas with temperatures below -4°F (-20°C) or above $+140^{\circ}\text{F}$ ($+60^{\circ}\text{C}$) or, in areas subject to direct sunlight, such as the dashboard.

AVOID the use of chemical agents such as benzine or alcohol when cleaning, as they may damage the transceiver surfaces.

BE CAREFUL! The transceiver rear panel will become hot when operating continuously for long periods.

Place the transceiver in a secure place to avoid inadvertent use by children.

BE CAREFUL! The transceiver and optional HM-127 employ waterproof construction, which corresponds to JIS waterproof specification, grade 7 (1 m/30 min.). However, once the transceiver or microphone has been dropped, waterproofing cannot be guaranteed due to the fact that the case may be cracked, or the waterproof seal damaged, etc.

CLEAN THE TRANSCEIVER AND MICROPHONE THOROUGHLY WITH FRESH WATER after exposure to water including fresh water, otherwise, the keys and switches may become inoperable due to salt crystallization.

PRIORITIES

- Read all rules and regulations pertaining to priorities and keep an up-to-date copy handy. Safety and distress calls take priority over all others.
- You must monitor channel 16 when you are not operating on another channel.
- False or fraudulent distress signals are prohibited and punishable by law.

PRIVACY

- Information overheard but not intended for you cannot lawfully be used in any way.
- Indecent or profane language is prohibited.

RADIO LICENSES

(1) SHIP STATION LICENSE

You must have a current radio station license before using the transceiver. It is unlawful to operate a ship station which is not licensed.

Inquire through your dealer or the appropriate government agency for a Ship-Radiotelephone license application. This government-issued license states the call sign which is your craft's identification for radio purposes.

(2) OPERATOR'S LICENSE

A Restricted Radiotelephone Operator Permit is the license most often held by small vessel radio operators when a radio is not required for safety purposes.

The Restricted Radiotelephone Operator Permit must be posted or kept with the operator. Only a licensed radio operator may operate a transceiver.

However, non-licensed individuals may talk over a transceiver if a licensed operator starts, supervises, ends the call and makes the necessary log entries.

Keep a copy of the current government rules and regulations handy.

Radio license for boaters (U.S.A. only)

The Telecommunications Act of 1996 permits recreational boaters to have and use a VHF marine radio, EPIRB, and marine radar without having an FCC ship station license. Boaters traveling on international voyages, having an HF single sideband radiotelephone or marine satellite terminal, or required to carry a marine radio under any other regulation must still carry an FCC ship station license. For further information, see the FCC Ship Radio Stations Fact Sheet.

■ Panel description

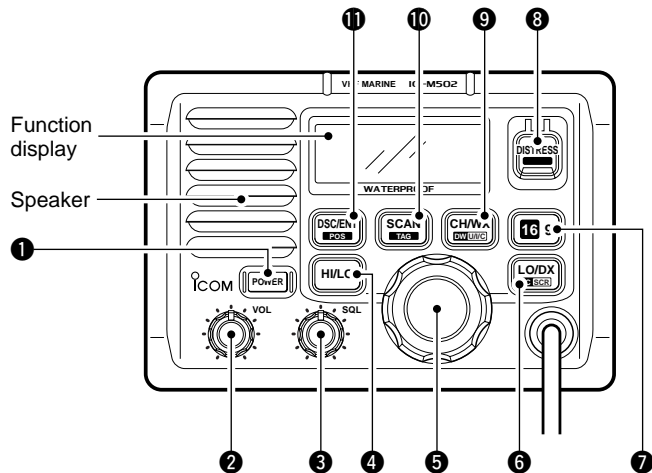

1 POWER SWITCH [POWER]

Push to toggle the transceiver power ON and OFF.

2 VOLUME CONTROL [VOL]

Adjusts the audio level. (p. 8)

3 SQUELCH CONTROL [SQL]

Sets the squelch threshold level. (p. 8)

4 TRANSMIT POWER SWITCH [HI/LO]

↳ Toggles high and low power when pushed. (p. 8)

• Some channels are set to low power only.

↳ While pushing this switch, other switches perform secondary functions.

5 CHANNEL SELECTOR [CHANNEL]

↳ Rotate [CHANNEL] to select the operating channels, set mode contents, etc. (p. 8)

- ➔ While pushing [HI/LO], rotate [CHANNEL] to adjust the brightness of the LCD and switch backlight.

6 ATTENUATOR/INTERCOM/SCRAMBLER SWITCH [LO/DX•IC•SCR]

- ➔ Toggles the attenuator function ON and OFF when pushed momentarily. (p. 8)
 - “LOCAL” appears when the attenuator is in use. The order of indication precedence is “LOCAL,” “SP OFF” and “CALL.”
- ➔ Activates an optional intercom function when pushed for 1 sec. (p. 29)
- ➔ Calls optional HM-127 REMOTE-CONTROL MICROPHONE when pushed and held while in intercom mode. (p. 29)
- ➔ While pushing [HI/LO], activates an optional voice scrambler function. (p. 10)
 - The optional voice scrambler function cannot be used on channel 16 and 70.

7 CHANNEL 16/CALL CHANNEL SWITCH [16•9]

- ➔ Selects channel 16 when pushed. (p. 6)
- ➔ Selects call channel when pushed for 1 sec. (p. 6)
 - “CALL” appears when call channel is selected. “LOCAL” and “SP OFF” indications have priority.
- ➔ Push for 3 sec. to enter call channel programming condition when call channel is selected. (p. 9)
- ➔ While pushing [HI/LO], enters memory name programming condition. (p. 9)
- ➔ Enters set mode when pushed while turning power ON. (p. 30)

8 DISTRESS SWITCH [DISTRESS]

- ➔ Transmits distress call when pushed for 5 sec. (p. 16)

9 CHANNEL/DUALWATCH/TRI-WATCH SWITCH [CH/WX•DW•U//C]

- ➔ Selects and toggles the regular channels and weather channel when pushed momentarily. (pgs. 6, 7)
- ➔ While pushing [HI/LO], selects one of 3 regular channels in sequence when pushed. (pgs. 6, 7)
 - International, U.S.A. and Canadian channels are available for regular channels.
- ➔ Starts dualwatch or tri-watch when pushed for 1 sec. (p. 11)
- ➔ Stops dualwatch or tri-watch when either is activated.

10 SCAN SWITCH [SCAN•TAG] (p. 13)

- ➔ Starts and stops normal or priority scan when tag channels are programmed.
- ➔ Push [SCAN•TAG] for 1 sec. to set the displayed channel as a tag (scanned) channel.
- ➔ While pushing [HI/LO], push for 3 sec. to clear all tag channels.

11 DSC/POSITION SWITCH [DSC/ENT•POS]

- ➔ Selects the DSC menu when pushed. (p. 14)
- ➔ Shows current position and time from an optional GPS receiver, etc. when pushed for 1 sec. (p. 15)

2 PANEL DESCRIPTION

■ Function display

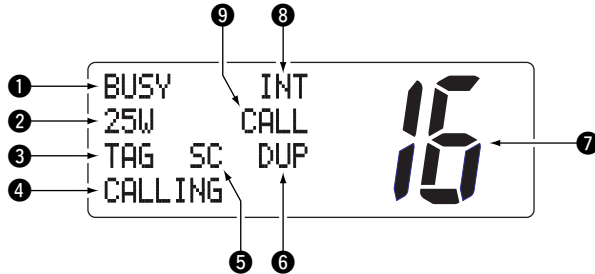

1 BUSY/TRANSMIT INDICATOR (p. 8)

- “BUSY” appears when receiving a signal or when the squelch opens.
- “TX” appears while transmitting.

2 POWER INDICATOR (p. 8)

- “25W” appears when high power is selected.
- “1W” appears when low power is selected.

3 TAG CHANNEL INDICATOR (p. 13)

Appears when a tag channel is selected.

4 CHANNEL NAME INDICATOR

- Channel comment appears if programmed. (p. 9)

- “Low battery” flashes when the battery voltage drops to approx. 10 V DC or below.
- “DUAL” appears during dualwatch; “TRI” appears during tri-watch. (p. 11)

5 SCRAMBLER INDICATOR (p. 10)

Appears when an optional voice scrambler is activated.

6 DUPLEX INDICATOR (p. 6)

Appears when a duplex channel is selected.

7 CHANNEL NUMBER READOUT

- Indicates the selected operating channel number. “A” appears when a simplex channel is selected. (p. 6)
- In set mode, indicates the selected condition. (p. 30)

8 CHANNEL GROUP INDICATOR (p. 6)

Indicates whether an International (INT), U.S.A. (USA), Canadian (CANADA) or weather (WX) channel is selected.

9 CALL CHANNEL INDICATOR

- “CALL” appears when the call channel is selected. (p. 6)
- “SP OFF” appears when the internal speaker is turned OFF in set mode. (p. 32)
- “LOCAL” appears when the attenuator is in use. (p. 8)
 - The order of indication precedence is “LOCAL,” “SP OFF” and “CALL.”

■ Microphone

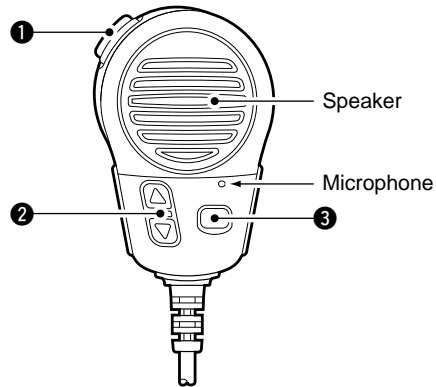

① PTT SWITCH [PTT]

Push and hold to transmit; release to receive. (p. 8)

② CHANNEL UP/DOWN SWITCHES [▲]/[▼]

Push either switch to change the operating memory channel, set mode contents, etc. (p. 8)

③ TRANSMIT POWER SWITCH [HI/LO]

- ➔ Same as the [HI/LO] switch on the front panel. (p. 8)
- ➔ While pushing [HI/LO] on the supplied microphone, turn power ON to toggle the lock function ON and OFF. (p. 7)

■ Channel selection

Channel 16

Channel 16 is the distress and safety channel. It is used for establishing initial contact with another station and for emergency communications. Channel 16 is monitored during both dualwatch and tri-watch. While standing by, you must monitor channel 16.

- ➔ Push [16•9] momentarily to select channel 16.
- ➔ Push [CH/WX] to return to the condition before selecting channel 16, or rotate [CHANNEL] to select operating channel.

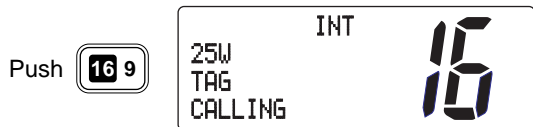

Channel 9 (Call channel)

Each regular channel group has a separate leisure-use call channel. The call channel is monitored during tri-watch. The call channels can be programmed (p. 9) and are used to store your most often used channels in each channel group for quick recall.

- ➔ Push [16•9] for 1 sec. to select the call channel of the selected channel group.
 - “CALL” and call channel number appear.
 - Each channel group may have an independent call channel after changing a call channel.
- ➔ Push [CH/WX] to return to the condition before selecting call channel, or rotate [CHANNEL] to select operating channel.

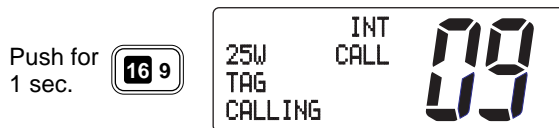

U.S.A., Canadian and international channels

There are 57 U.S.A., 61 Canadian and 57 international channels. These channel groups may be specified for the operating area.

- ① Push [CH/WX] to select a regular channel.
 - If a weather channel appears, push [CH/WX] again.
- ② Push [CH/WX•U/I/C] while pushing [HI/LO] to change the channel group, if necessary.
 - U.S.A., International (INT) and Canadian channels can be selected in sequence.
- ③ Rotate the channel selector to select a channel.
 - “DUP” appears for duplex channels.
 - “A” appears for simplex channels.

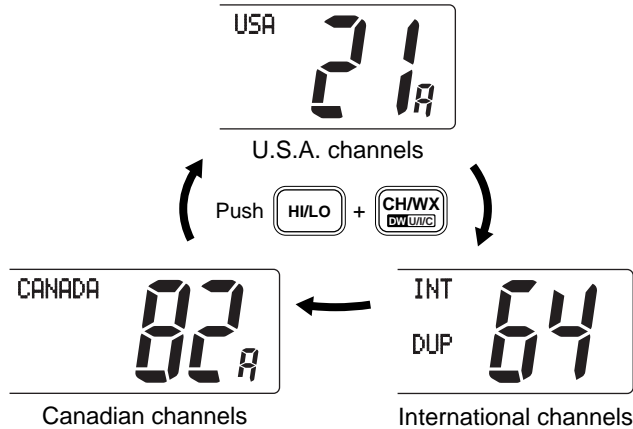

Weather channels

There are 10 weather channels. Used for monitoring weather channels from the NOAA (National Oceanographic and Atmospheric Administration) broadcasts.

The transceiver can detect a weather alert tone on the selected weather channel while receiving the channel, during standby on a regular channel or while scanning. See "Weather alert" on p. 31.

- ① Push [CH/WX] once or twice to select a weather channel.
 - "WEATHER" appears when a weather channel is selected. "WX ALT" appears when the weather alert function is in use. (p. 31)
- ② Rotate the channel selector to select a channel.
 - Channels are memorized separately for each channel group.

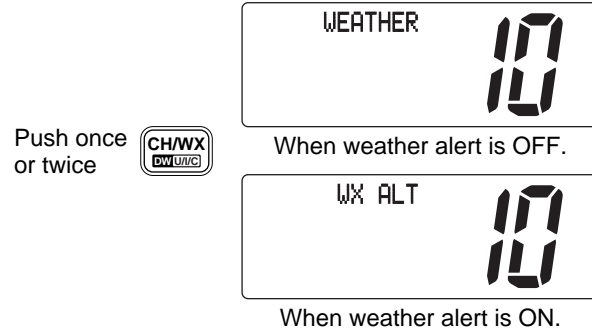

Microphone lock function

The microphone lock function electrically locks the [▲]/[▼] and [HI/LO] switches on the supplied microphone. This prevents accidental channel changes and accidental function access.

- ➔ While pushing [HI/LO] on the supplied microphone, turn power ON to toggle the lock function ON and OFF.

3 BASIC OPERATION

■ Receiving and transmitting

CAUTION: Transmitting without an antenna may damage the transceiver.

- 1 Push [POWER] to turn power ON.
- 2 Set the audio and squelch levels.
 - ➔ Rotate [SQL] fully counterclockwise in advance.
 - ➔ Rotate [VOL] to adjust the audio output level.
 - ➔ Rotate [SQL] clockwise until the noise disappears.
- 3 To change the channel group, push [CH/WX•DW•U/I/C] while pushing [HI/LO]. (p. 6)
- 4 Rotate the channel selector or push [▲]/[▼] on the microphone to select the desired channel.
 - When receiving a signal, “BUSY” appears and audio is emitted from the speaker.
 - Further adjustment of [VOL] may be necessary at this point.
 - Use the optional voice scrambler function for privacy. (p. 10)
- 5 Push [LO/DX] to turn the receive attenuator ON or OFF if necessary.
 - “LOCAL” appears when the receive attenuator is in use.
- 6 Push [HI/LO] to select the output power if necessary.
 - “25W” or “1W” appears when high or low power is selected, respectively.
 - Choose low power to conserve power, choose high power for longer distance communications.
 - Some channels are for low power only.

- 7 Push and hold [PTT] to transmit, then speak into the microphone.
 - “TX” appears.
 - Channel 70 cannot be used for transmission (for GMDSS use).

Simplex channels, 3, 21, 23, 61, 64, 81, 82 and 83 **CAN-NOT** be lawfully used by the general public in U.S.A. waters.

- 8 Release [PTT] to receive.

IMPORTANT: To maximize the readability of your transmitted signal, pause a few sec. after pushing [PTT], hold the microphone 4 to 6 inches (10 to 15 cm) from your mouth and speak at a normal voice level.

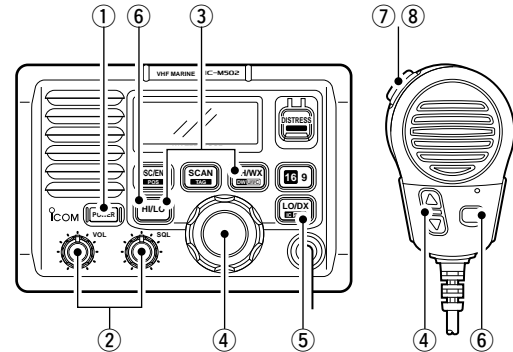

■ Call channel programming

The call channel is used to select channel 9, however, you can program your most often-used channels in each channel group for quick recall.

- ① While pushing [HI/LO], push [CH/WX•DW•U/I/C] one or more times to select the desired channel group (U.S.A., International, Canada) to be programmed.
- ② Push [16•9] for 1 sec. to select the call channel of the selected channel group.
 - “CALL” and call channel number appear.
 - The order of indication precedence is “LOCAL,” “SP OFF” and “CALL.”
- ③ Push [16•9] again for 3 sec. (until long beep changes to 2 short beeps) to enter call channel programming condition.
 - Channel number starts flashing.
- ④ Rotate the channel selector to select the desired channel.
- ⑤ Push [16•9] to program the displayed channel as the call channel.
 - Push [CH/WX] to cancel.
 - The channel number stops flashing.

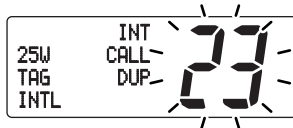

■ Channel names

Memory channels can be tagged with alphanumeric names of up to 10 characters each.

Capital letters, small letters, numerals, some symbols (! " # \$ % & ' () * + , - . /) and spaces can be used.

- ① Select the desired memory channel.
 - Cancel dual watch, tri-watch or scan in advance.
- ② While pushing [HI/LO], push [16•9] to edit memory channel name.
 - A cursor appears and blinks.

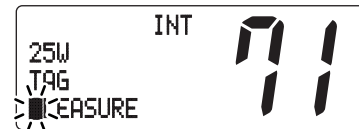

- ③ Select the desired character by rotating the channel selector or by pushing [▲]/[▼] on the microphone.
 - Push [SCAN] or [CH/WX] for cursor movement.
- ④ Push [16•9] to input and set the name.
 - Push [HI/LO] to cancel.
 - The cursor disappears.
- ⑤ Repeat steps ① to ④ to program other memory channel names, if desired.

3 BASIC OPERATION

■ Optional voice scrambler operation

Activating the scrambler

The optional voice scrambler provides private communications. In order to receive or send scrambled transmissions you must first activate the scrambler function. To activate the function, an optional UT-98 or UT-112 is necessary. See p. 33 for selecting the unit. Ask your dealer for details.

/// The scrambler function automatically turns OFF when channel 16 or 70 is selected.

- ① Select an operating channel other than channel 16 and 70.
- ② While pushing [HI/LO], push [LO/DX•IC/SCR] to toggle an optional scrambler function ON or OFF.
 - “SC” appears.
- ③ To turn the scrambler function OFF, repeat step ②.
 - “SC” disappears.

Programming scrambler codes

There are 128 or 32 codes (0 to 127 or 1 to 32) available for programming when the optional UT-98 or UT-112 is installed. In order to understand one another, all transceivers in your group must have the same scramble code. This function may not be available depending on dealer setting.

- ① Turn power OFF.
- ② While pushing [16•9], turn power ON to enter set mode.
- ③ After the display appears, release [16•9].
- ④ Push [16•9] one or more times to select the scrambler code item.
 - “Scrambler code” appears.
- ⑤ Rotate the channel selector to select the desired scrambler code.
- ⑥ Turn power OFF, then ON again to exit set mode.

[Example]: Programming scrambler code 127.

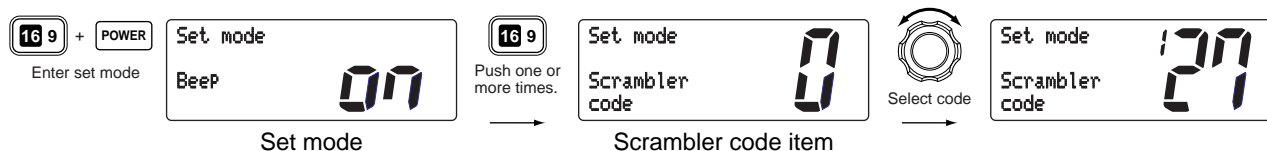

■ Description

Dualwatch monitors channel 16 while you are receiving another channel; tri-watch monitors channel 16 and the call channel while receiving another channel.

DUALWATCH/TRI-WATCH SIMULATION

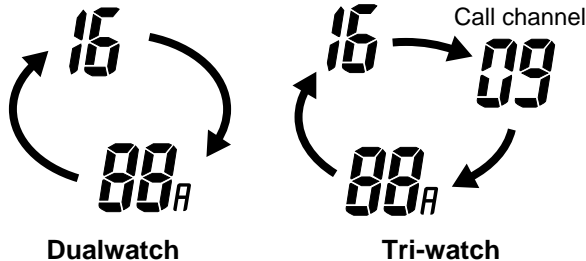

- If a signal is received on channel 16, dualwatch/tri-watch pauses on channel 16 until the signal disappears.
- If a signal is received on the call channel during tri-watch, tri-watch becomes dualwatch until the signal disappears.
- To transmit on the selected channel during dualwatch/tri-watch, push and hold [PTT].

■ Operation

- ① Select the desired operating channel.
- ② Select dualwatch or tri-watch in set mode. (p. 31)
- ③ Push [CH/WX•DW•U/I/C] for 1 sec. to start dualwatch or tri-watch.
 - “DUAL” appears during dualwatch; “TRI” appears during tri-watch.
 - Beep tone sounds when a signal is received on channel 16.
- ④ To cancel dualwatch/tri-watch, push [CH/WX•DW•U/I/C] again.

[Example]: Operating tri-watch on INT channel 25.

25W TAG TRI	INT DUP 16	25	Tri-watch starts.
BUSY 25W TAG TRI	INT CALL 16	09	Signal is received on call channel.
BUSY 25W TAG TRI	INT DUP 16	25	Signal received on channel 16 takes priority.
25W TAG TRI	INT DUP 16	25	Tri-watch resumes after the signal disappears.

■ Scan types

Scanning is an efficient way to locate signals quickly over a wide frequency range. The transceiver has priority scan and normal scan.

When the weather alert function is in use, the selected weather channel is checked while scanning. (p. 31)

Set the tag channels (scanned channel) before scanning. Clear the tag channels which inconveniently stop scanning, such as digital communication use.

/// Choose priority or normal scan in set mode. (p. 31)

PRIORITY SCAN

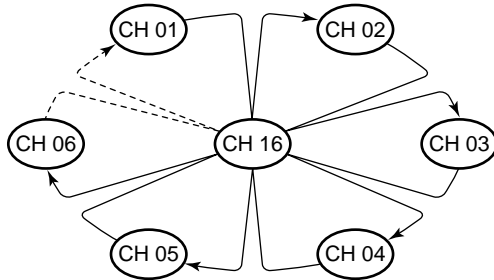

Priority scan searches through all tag channels in sequence while monitoring channel 16. When a signal is detected on channel 16, scan pauses until the signal disappears; when a signal is detected on a channel other than channel 16, scan becomes dualwatch until the signal disappears.

NORMAL SCAN

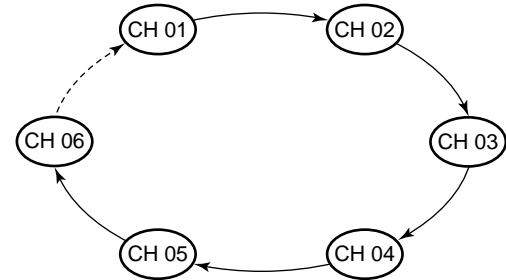

Normal scan, like priority scan, searches through all tag channels in sequence. However, unlike priority scan, channel 16 is not checked unless channel 16 is set as a tag channel.

■ Setting tag channels

For more efficient scanning, add desired channels as tag channels or clear tag channels for unwanted channels. Channels set as non-tag channels will be skipped during scanning. Tag channels can be assigned to each channel group (U.S.A., International, Canada) independently.

- ① While pushing [HI/LO], push [CH/WX•DW•U/I/C] one or more times to select the desired channel group, if desired.
- ② Select the desired channel to set as a tag channel.
- ③ Push [SCAN•TAG] for 1 sec. to set the displayed channel as a tag channel.
 - “TAG” appears in the function display.
- ④ To cancel the tag channel setting, repeat ③.
 - “TAG” disappears.

•Clearing all tag channels in the selected channel group

- While pushing [HI/LO], push [SCAN•TAG] for 3 sec. to clear all tag channels in the channel group.

■ Starting a scan

Set scan type (priority or normal scan) and scan resume timer in advance using set mode. (p. 31)

- ① Set tag channels as described at left.
- ② Make sure the squelch is closed to start a scan.
- ③ While pushing [HI/LO], push [CH/WX•DW•U/I/C] one or more times to select the desired channel group, if desired.
- ④ Push [SCAN] to start priority or normal scan.
 - “Pri scan 16” or “Normal scan” appears in the function display.
 - When a signal is detected, scan pauses until the signal disappears or resumes after pausing 5 sec. according to set mode setting. (Channel 16 is still monitored during priority scan.)
 - Rotate the channel selector to check the scanning tag channels, to change the scanning direction or resume the scan manually.
 - “16” flashes and a beep tone sounds when a signal is received on channel 16 during priority scan.
 - Push [SCAN•TAG] for 1 sec. to set the paused channel as a tag channel.
- ⑤ To stop the scan, push [SCAN].

[Example]: Starting a normal scan.

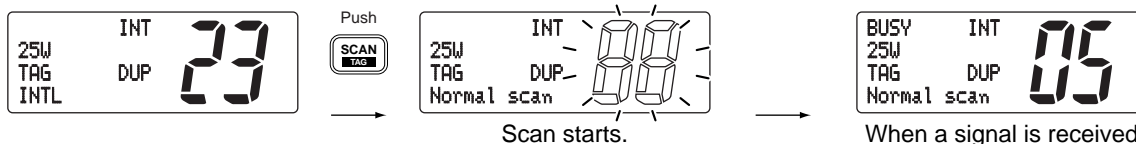

■ MMSI code programming

The 9-digit MMSI (DSC self ID) code can be programmed at power ON.

▨ This function is not available when the MMSI code has been programmed by the dealer. This code programming can be performed only 2 times.

- ① Turn power OFF.
- ② While pushing [DSC/ENT], turn power ON to enter MMSI code programming condition.
- ③ After the display appears, release [DSC/ENT].

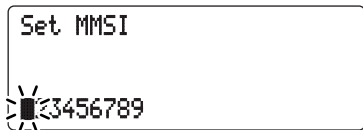

- ④ Select the desired number by rotating the channel selector.
- ⑤ Push [CH/WX] to advance the cursor.
 - Push [SCAN] to move the cursor backward.
- ⑥ Repeat steps ④ and ⑤ to input 9 digit code.
- ⑦ Push [DSC/ENT] to input and set the code.
 - The previously selected channel appears.

■ Position and time programming

A distress call should include the ship's position and time. If no GPS is connected, your position and UTC (Universal Time Coordinated) time should be input. They are included automatically when a GPS receiver (NMEA0183 ver. 2.0) is connected.

▨ This function is not available when an optional GPS receiver (NMEA0183 ver. 2.0) is connected.

- ① Push [DSC/ENT] twice to enter the position programming condition.



- ② Rotate the channel selector to select the digit of your position.
- ③ Push [CH/WX] to advance the cursor.
 - Push [SCAN] to move the cursor backward.
 - Push [HI/LO] to clear the position data.

- ④ Push [DSC/ENT] to set the position and advance to time setting condition.
- Push [LO/DX] to abandon the setting and exit the condition.



- ⑤ Rotate the channel selector to select the digit of current UTC time.
- ⑥ Push [CH/WX] to advance the cursor.
- Push [SCAN] to move the cursor backward.
 - Push [HI/LO] to clear the time.
- ⑦ Push [DSC/ENT] to set the time.
- Push [LO/DX] to abandon the setting and exit the condition.

■ Position indication

When an optional GPS receiver (NMEA0183 ver. 2.0) is connected, the transceiver can display the current position and time. When no GPS receiver is connected, the transceiver displays the manually entered position and time.

A GPS receiver appropriate for the IC-M502 is not supplied from Icom. An NMEA0183 ver. 2.0 is required for position indication. Ask your dealer about the GPS receiver.

- ➔ Push [DSC/ENT•POS] for 1 sec. to display the current position and time.
- "MNL" (manual) appears instead of the "GPS" indication when the position data is entered manually.

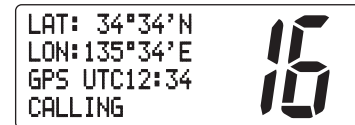

6 DSC OPERATION

■ Distress call

A distress call should be transmitted if, in the opinion of the Master, the ship or a person is in distress and requires immediate assistance.

NEVER USE THE DISTRESS CALL WHEN YOUR SHIP IS NOT IN AN EMERGENCY. A DISTRESS CALL CAN BE USED ONLY WHEN IMMEDIATE HELP IS NEEDED.

- ① Confirm any distress call is not being received.
- ② While lifting up the switch cover, push the [DISTRESS] switch for 5 sec. to transmit the distress call.
 - An emergency channel (Ch 70) is automatically selected and the distress call is transmitted.
 - If no GPS is connected, input your position and UTC time, if possible.

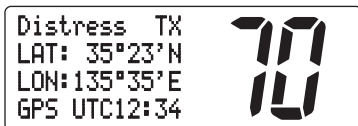

Distress TX
LAT: 35°23'N
LON: 135°35'E
GPS UTC12:34

- ③ After transmitting the call, the transceiver waits for an acknowledgment call on Ch70.
 - The distress call is automatically transmitted every 3.5 to 4.5 minutes.

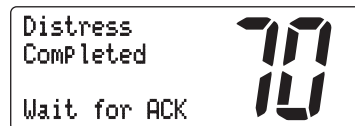

Distress
Completed
Wait for ACK

- ④ When receiving the acknowledgment, reply to the connected station via the microphone.

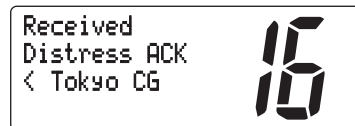

Received
Distress ACK
< Tokyo CG

- ➔ Distress alert contains (default);
 - Kinds of distress : Undesignated distress
 - Position data : GPS or manual input position data held for 23.5 hrs. or until the power is turned OFF.
- ➔ The distress call is repeated every 3.5–4.5 min., until receiving an 'acknowledgement.'
- ➔ Push [DISTRESS] to transmit a renewed distress call, if desired.
- ➔ Push [16•9] to cancel the 'Call repeat' mode.
- ➔ '??' may blink instead of position and time indications, when the GPS data is invalid, or 4 hours after the time data is input manually.

■ Transmitting DSC calls

Transmitting individual call

The individual call function allows you to transmit a DSC signal to a specific party only.

- ① Select a desired channel other than channel 70.
- ② Push [DSC/ENT] to select the DSC menu.

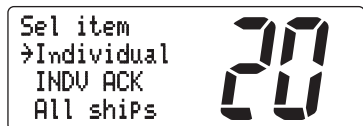

- ③ Rotate the channel selector to select “individual” and push [DSC/ENT].
- ④ Rotate the channel selector to select the desired pre-programmed individual address; or push [DSC/ENT] while “Manual set” is displayed, to set the ID code for the individual you wish to call.
 - The ID code for the individual call can be set in advance. (p. 22)



- ⑤ Push [DSC/ENT] to transmit the individual call.
 - Channel 70 is selected and the individual call is transmitted to the selected station.
 - If channel 70 is busy, the transceiver standbys until the channel becomes clear.
 - Routine category only is available.



Push [DSC/ENT] to transmit DSC call. When Ch70 is busy.

- ⑥ Standby on channel 70 until an acknowledgement is received.

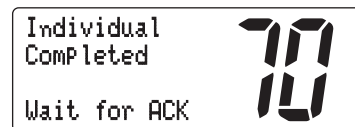

- ⑦ When the acknowledgement is received, the display changes to the previously selected user channel with beeps.
- ⑧ Push and hold [PTT] to communicate your message to the responding party.

6 DSC OPERATION

Transmitting individual acknowledgement

Transmit an acknowledgement ('able to comply' or 'unable to comply') when an individual call for you is received.

- ① Select a desired channel other than channel 70.
- ② Push [DSC/ENT] to select the DSC menu.
- ③ Rotate the channel selector to select "INDV ACK" and push [DSC/ENT].
 - "INDV ACK" appears after an individual call is received.

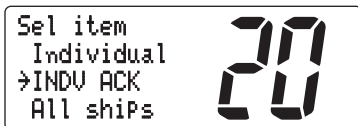

- ④ Rotate the channel selector to select the desired individual address or ID code, then push [DSC/ENT].



- ⑤ Rotate the channel selector to select an acknowledgement ('Able' or 'Unable'), then push [DSC/ENT].



- ⑥ If you select 'Unable,' select the reason by rotating the channel selector, then push [DSC/ENT].
 - 'No reason given,' 'Congestion,' 'Busy,' 'Queue indication,' 'Barred (Station barred),' 'No operator,' 'No Equip (Equipment disable),' 'No channel (Unable channel)' and 'No mode (Unable mode)' are available.

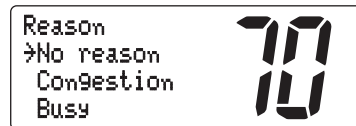

- ⑦ Push [DSC/ENT] to transmit the acknowledgement to the selected station.

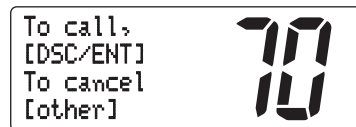

- ⑧ The individual acknowledgement has been transmitted.

Transmitting all ships call

Large ships use channel 70 as their “listening channel.” When you want to announce a message to these ships, use the “all ships call” function.

- ① Select a desired channel other than channel 70.
- ② Push [DSC/ENT] to select the DSC menu.
- ③ Rotate the channel selector to select “All ships” and push [DSC/ENT].

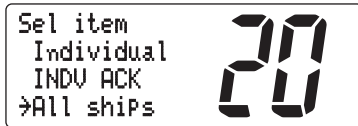

- ④ Push [DSC/ENT] to transmit the all ships call.
 - Channel 70 is selected and the all ships call is transmitted.
 - Routine category only is available.

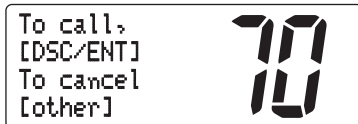

- ⑤ The all ships call has been transmitted.

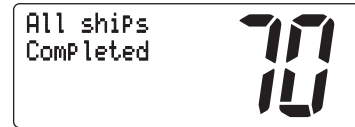

- ⑥ Push [PTT] or rotate the channel selector to exit the condition.

6 DSC OPERATION

Transmitting position request call

Transmit a position request call when you want to know your friend's current position, etc.

- ① Select a desired channel other than channel 70.
- ② Push [DSC/ENT] to select the DSC menu.
- ③ Rotate the channel selector to select "POS request" and push [DSC/ENT].



- ④ Push [DSC/ENT] to transmit the position request call.
 - Channel 70 is selected and the position request call is transmitted.

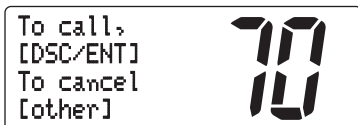

- ⑤ The position request call has been transmitted.

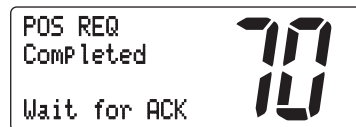

- ⑥ Push [PTT] or rotate the channel selector to exit the condition.

Transmitting position reply call

Transmit a position reply call when a position request call is received.

- ① When a position request call is received, the function display shows as follows.



- ② Push [DSC/ENT] to reply the position request call; push [HI/LO] to ignore the position request call.

6 DSC OPERATION

■ DSC individual ID

A total of 40 DSC address ID's can be programmed and named with up to 10 characters.

Programming address ID

- ① Push [DSC/ENT] to select the DSC menu.
- ② Rotate the channel selector to select "Set-up" and push [DSC/ENT].

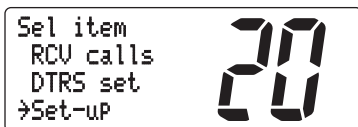

- ③ Rotate the channel selector to select 'Add ID,' then push [DSC/ENT].

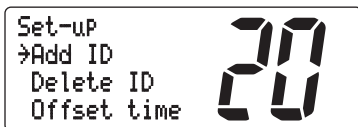

- ④ Set the distress ID and ID name, then push [DSC/ENT].
 - Rotate the channel selector to select the character.
 - Push [CH/WX] to advance the cursor.
 - Push [SCAN] to move the cursor backward.
 - Push [HI/LO] to cancel and exit the condition.



- ⑤ Push [DSC/ENT] to program and to exit the condition.

Deleting address ID

- ① Push [DSC/ENT] to select the DSC menu.
- ② Rotate the channel selector to select "Set-up" and push [DSC/ENT].



- ③ Rotate the channel selector to select 'Delete ID,' then push [DSC/ENT].
 - When no address ID is programmed, the transceiver exits the condition automatically.



- ④ Select the desired ID name with the channel selector, then push [DSC/ENT].



- ⑤ Push [DSC/ENT] to delete the address ID; push other switch to exit the condition.

■ Receiving DSC calls

Receiving a distress call

While monitoring channel 70 and a distress call is received:

- ↳ Emergency alarm sounds for 2 minutes.
 - Push any switch to stop the alarm.
- ↳ “Received Distress” appears in the display; then, channel 16 is automatically selected.
- ↳ Continue monitoring channel 16 as a coast station may require assistance.

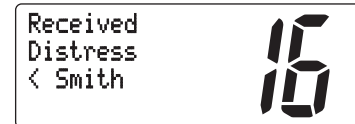

Receiving a distress acknowledgement

While monitoring channel 70 and a distress acknowledgement to other ship is received:

- ↳ Emergency alarm sounds for 2 minutes.
 - Push any switch to stop the alarm.
- ↳ “Received Distress ACK” appears in the display; then, channel 16 is automatically selected.

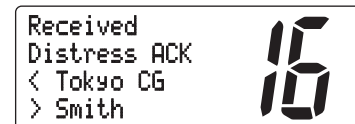

6 DSC OPERATION

Receiving a distress relay acknowledgement

While monitoring channel 70 and a distress relay acknowledgement is received:

- ➔ Emergency alarm sounds for 2 minutes.
 - Push any switch to stop the alarm.
- ➔ “Received DTRS RLY ACK” appears in the display; then, channel 16 is automatically selected.

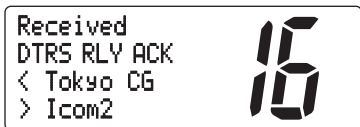

Receiving a distress relay call

While monitoring channel 70 and a distress relay call is received:

- ➔ Emergency alarm sounds for 2 minutes.
 - Push any switch to stop the alarm.
- ➔ “Received Distress RLY” appears in the display; then, channel 16 is automatically selected.
- ➔ Monitor channel 16 until the emergency communication has been completed.

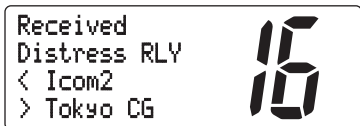

Receiving an all ships call

While monitoring channel 70 and an all ships call is received:

- ➔ Emergency alarm sounds when the category is “Distress” or “Urgency;” 3 beeps sound for other categories.
- ➔ “All ships Distress,” “All ships Safety” or “All ships Urgency” appears in the display; then, the channel specified by the calling station is automatically selected for voice communication.
- ➔ Monitor the selected channel for an announcement from the calling vessel.

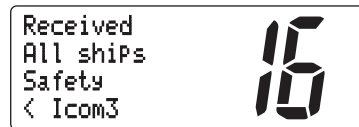

Receiving an individual call

While monitoring channel 70 and an individual call is received:

- ➔ Emergency alarm or beeps sound depending on the received category.
- ➔ “Individual Distress,” “Individual Safety,” “Individual Urgency” or “Individual Routine” appears in the display.
- ➔ The channel specified by the calling station is automatically selected for checking the channel condition.

```
Received
Individual
Routine
< Icom3
```



Receiving a geographical area call

While monitoring channel 70 and a geographical area call (for the area you are in) is received:

- ➔ Emergency alarm or beeps sound depending on the received category.
- ➔ “Geographic Distress,” “Geographic Safety,” “Geographic Urgency” or “Geographic Routine” appears in the display; then, the channel specified by the calling station is automatically selected for voice communications.
- ➔ Monitor the selected channel for an announcement from the calling ship.

```
Received
Geographic
Routine
< Tokyo CG
```



When no GPS receiver is connected or if there is a problem with the connected receiver, all geographical area calls are received, regardless of your position.

Receiving a position reply call

While monitoring channel 70 and a position reply call (for the area you are in) is received:

- ➔ “Received POS” appears in the display.

```
Received POS
< TOM
LAT: 34°34'N
LON: 135°34'E
```



When no GPS receiver is connected or if there is a problem with the connected receiver, all geographical area calls are received, regardless of your position.

Receiving a position request call

While monitoring channel 70 and a position request call (for the area you are in) is received:

- ➔ “POS request” appears in the display.
- ➔ Push [DSC/ENT] to reply to the call.

```
Received
POS request
< Smith
Ans[DSC/ENT]
```



When no GPS receiver is connected or if there is a problem with the connected receiver, all geographical area calls are received, regardless of your position.

6 DSC OPERATION

■ DSC set mode

Offset time

This item sets the offset time from the UTC (Universal Time Coordinated) time.

- ① Push [DSC/ENT] to select the DSC menu.
- ② Rotate the channel selector to select "Set-up" and push [DSC/ENT].



- ③ Rotate the channel selector to select 'Offset time,' then push [DSC/ENT].

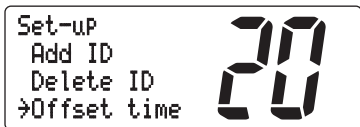

- ④ Set the offset time from the UTC (Universal Time Coordinated) time, then push [DSC/ENT].
 - Rotate the channel selector to select the number, '+' or '-.'
 - Push [CH/WX] to advance the cursor.
 - Push [SCAN] to move the cursor backward.
 - Push [HI/LO] to cancel and exit the condition.



No offset time (default)

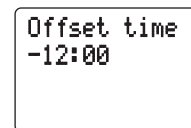

-12 hours

- ⑤ Push [DSC/ENT] to program and to exit the condition.

MMSI code check

The 9-digit MMSI (DSC self ID) code can be checked in set mode.

- ① Push [DSC/ENT] to select the DSC menu.
- ② Rotate the channel selector to select “Set-up” and push [DSC/ENT].



- ③ Rotate the channel selector to select ‘MMSI check,’ then push [DSC/ENT].



- ④ Check the 9-digit MMSI (DSC self ID) code.



- ⑤ Push [DSC/ENT] to exit the condition.

6 DSC OPERATION

■ Receive messages

The transceiver automatically stores up to 20 distress messages and 20 other messages. The messages can be used as an assistance to the logbook.

- ① Push [DSC/ENT] to select the DSC menu.
- ② Rotate the channel selector to select "RCV calls" and push [DSC/ENT].
 - "RCV calls" does not appear until a distress call is received.

```
Sel item  
→RCV calls  
DTRS set  
Set-up
```



- ③ Rotate the channel selector to select distress messages or other messages, then push [DSC/ENT].

```
Sel Message  
→Distress  
Other
```



- ④ Rotate the channel selector to select the desired message, then push [DSC/ENT].

- ⑤ Rotate the channel selector to scroll the message.
 - The stored message has several information and depends on the distress call types.

```
Sel DTRS MSG  
→Smith  
Icom2  
John
```



```
Sel Message  
→All ships  
Individual  
Individual
```



```
Distress  
< Smith  
Explosion  
UTC: 12:34  
LAT: 12°34'N  
LON: 123°45'W  
  
To clear  
this data  
No [DSC/ENT]  
Yes [H/L]
```



```
All ships  
< Bill  
Safety  
F3E Simplex  
CH13  
  
To clear  
this data  
No [DSC/ENT]  
Yes [H/L]
```



- ⑥ Push [DSC/ENT] to exit the condition or push [HI/LO] to clear the displayed messages.

```
To clear  
this data  
No [DSC/ENT]  
Yes [H/L]
```



■ Intercom operation

The optional intercom function allows you to talk to the deck from the cabin. The optional HM-127 REMOTE-CONTROL MICROPHONE is required for intercom operation.

Connect an optional HM-127 as described on p. 35.

- Transmitting is impossible during intercom operation.
- The received signal is muted during intercom operation.

- ① Push [LO/DX•IC•SCR] for 1 sec. to enter intercom mode.
 - The HM-127 power is automatically turned ON, even if the power is OFF.

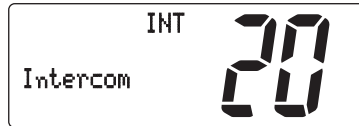

IC-M502



HM-127

- ② Push and hold [LO/DX•IC•SCR] again to call up.
 - The transceiver and microphone emit call beeps.
- ③ Push and hold the PTT switch and speak at a normal voice level into the microphone.
 - “TALK” or “LSTN” appears on the caller or listener function display, respectively.
 - To adjust the IC-M502’s speaker output level, rotate [VOL].

- To adjust the HM-127’s speaker output level, push [▲]/[▼] after pushing [VOL].

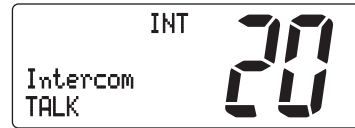

IC-M502 (caller)



HM-127 (listener)

- ④ After releasing the PTT switch you can hear the response through the speaker.
 - ⑤ To return to normal operation, push [LO/DX•IC•SCR] momentarily.
 - Other switches also turn the function OFF, however, the corresponding function is then activated e.g. pushing [16•9] selects channel 16.
- While in the intercom mode, the transceiver functions (transmit and receive) are interrupted. If the transceiver is in transmit condition, the intercom function is not available.
 - When a DSC call is received, “DSC received” appears and the last received DSC message is displayed after the intercom use is finished.
 - When a WX alert is received, “WX ALT” flashes and a beep sounds. The WX alert sounds after the intercom use is finished.

■ Set mode programming

Set mode is used to change the conditions of the transceiver's functions: scan mode (normal or priority), scan resume timer, weather alert, dualwatch/tri-watch selection, DSC watch, transceiver's beep tone, internal speaker (transceiver or HM-127), LCD contrast (transceiver or HM-127), RF attenuation level, scrambler code and scrambler type.

▨ Available functions may differ depending on dealer setting.

▨ The optional HM-127 has it's own settings for the beep tone and LCD contrast.

- ① Turn power OFF.
- ② While pushing [16•9], turn power ON to enter set mode.
- ③ After the display appears, release [16•9].
- ④ Push [16•9] to select the desired item, if necessary.
- ⑤ Rotate the channel selector to select the desired condition of the item. Use [▲]/[▼] when using an optional HM-127.
- ⑥ Turn power OFF, then ON again to exit set mode.

•SET MODE CONSTRUCTION

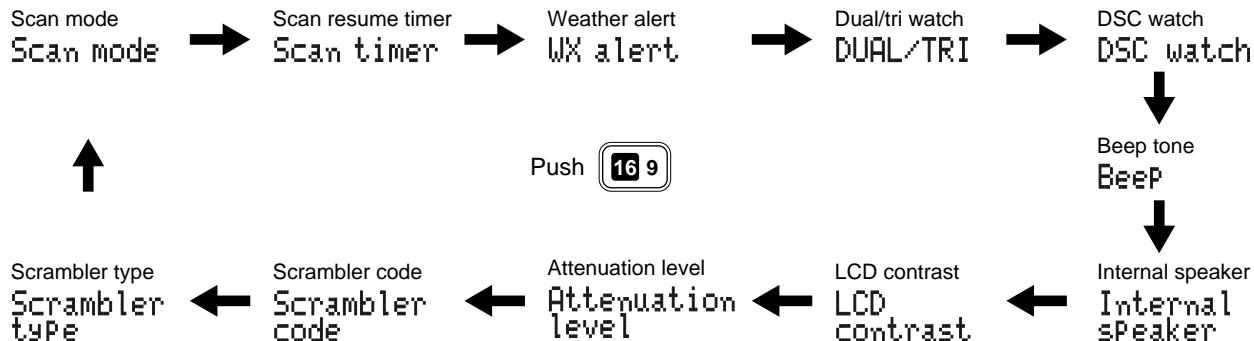

■ Set mode items

Scan mode

The transceiver has 2 scan modes: normal scan and priority scan. Normal scan searches all tag channels in the selected channel group. Priority scan searches all tag channels in sequence while monitoring channel 16.



Normal scan (default)



Priority scan

Scan resume timer

The scan resume timer can be selected as a pause (OFF) or timer scan (ON). When OFF is selected, the scan pauses until the signal disappears. When ON is selected, the scan pauses 5 sec. and resumes even if a signal is being received on channels except for channel 16.



Scan timer OFF (default)



Scan timer ON

Weather alert

An NOAA broadcast station transmits a weather alert tone before important weather information. When the weather alert function is turned ON, the transceiver detects the alert, then flashes the "WX ALT" indicator until the transceiver is operated. The previously selected (used) weather channel is checked any time during standby or while scanning.

- "WX ALT" appears instead of "WEATHER" indication when the function is set ON.

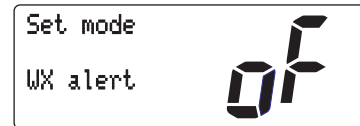

Weather alert OFF (default)



Weather alert ON

Dual/tri watch

This item sets the [CH/WX•DW] switch function as dual watch or tri-watch.

See the section 'Dual watch/Tri-watch' for details.

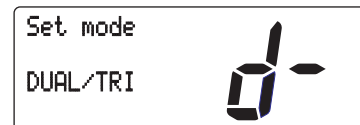

Dual watch (default)



Tri-watch

8 SET MODE

DSC watch

DSC watch monitors channel 70 while you are receiving another channel.

If a distress signal is received on channel 70, the transceiver monitors channel 16 and 70 alternately until the distress signal disappears. If a signal is received on another channel, DSC watch pauses until the signal disappears.



DSC watch ON (default)



DSC watch OFF

/// This function may not be available for some channel groups depending on dealer setting.

Beep tone

You can select silent operation by turning beep tones OFF or you can have confirmation beeps sound at the push of a switch by turning beep tones ON.

/// The optional HM-127 has it's own setting for the beep tone.



Beep tone ON (default)



Beep tone OFF

Internal speaker

When an optional external speaker is connected and the transceiver's internal speaker is not required, the speakers on the transceiver and microphone can be deactivated.

"SP OFF" appears on the function display when the internal speaker is turned OFF.

•The order of indication precedence is "LOCAL," "SP OFF" and "CALL."



Internal speaker ON (default)



Internal speaker OFF

LCD contrast

This item adjusts the contrast of the LCD in 8 steps.

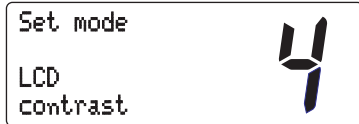

LCD contrast 4 (default)

⚡ The optional HM-127 has it's own setting for the beep tone.

Attenuation level

This item sets the receive attenuation level for the attenuator function from 3 levels.

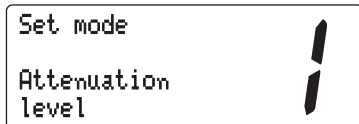

Attenuation level 1 (default)

Scrambler code

When an optional scrambler unit is connected, the scrambler code can be set depending on dealer setting.

When the UT-98 or UT-112 is installed, 128 or 32 codes (0 to 127 or 1 to 32) can be selected, respectively.

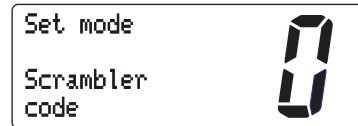

Scrambler code 0 (UT-98 default)



Scrambler code 127

Scrambler type

When an optional scrambler unit is connected, the scrambler type can be selected in set mode depending on dealer setting.



UT-98 scrambler unit



UT-112 scrambler unit

■ Supplied accessories

The following accessories are supplied: Qty.

① Mounting bracket	1
② Microphone hanger (OPC-562)	1
③ Mic hanger screws (3 × 16)	2
④ Mounting screws (5 × 20)	2
⑤ Flat washers (M5)	2
⑥ Spring washers (M5)	2
⑦ Mounting bracket knobs	2
⑧ DC power cable (OPC-946)	1

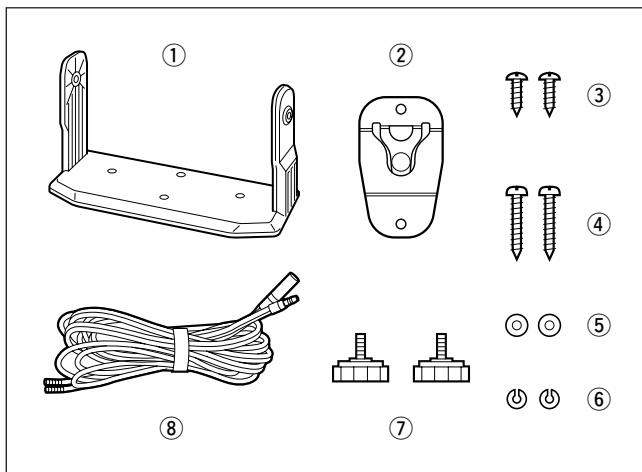

■ Antenna

A key element in the performance of any communication system is an antenna. Ask your dealer about antennas and the best places to mount them.

■ Fuse replacement

One fuse is installed in the supplied DC power cable. If a fuse blows or the transceiver stops functioning, track down the source of the problem, if possible, and replace the damaged fuse with a new, rated one.

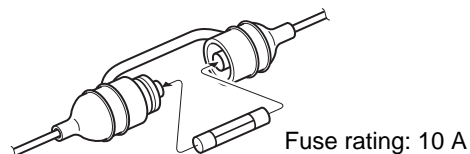

■ Cleaning

If the transceiver becomes dusty or dirty, wipe it clean with a soft, dry cloth.



AVOID the use of solvents such as benzene or alcohol, as they may damage transceiver surfaces.

■ Connections

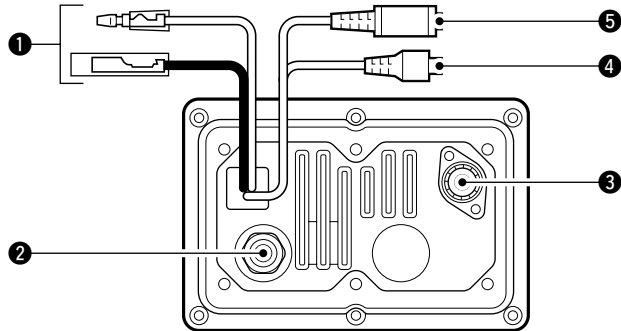

❶ DC POWER CONNECTOR

Connects the supplied DC power cable from this connector to an external 12 V DC power source.

❷ EXTERNAL MICROPHONE JACK

Connects to optional HM-127 REMOTE-CONTROL MICROPHONE.

❸ ANTENNA CONNECTOR

Connects a marine VHF antenna with a PL-259 connector to the transceiver.

CAUTION: Transmitting without an antenna may damage the transceiver.

❹ GPS RECEIVER JACK

Connects to an optional GPS receiver to input the position data and time data.

- A GPS receiver appropriate for the IC-M502 is not supplied from Icom. An NMEA0183 ver. 2.0 is required for position or time indication, etc. Ask your dealer about the GPS receiver.

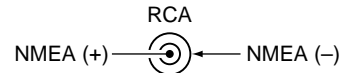

❺ EXTERNAL SPEAKER JACK

Connects to an external speaker. See 'Options' on p. 43 for available external speakers.

MICROPHONE HANGER

Rest the supplied microphone on the hanger when not in use.

CAUTION: After connecting the DC power cable, GPS receiver jack and external speaker jack, cover the connector and jacks with an adhesion tape as shown below to prevent water seeping into the transceiver.

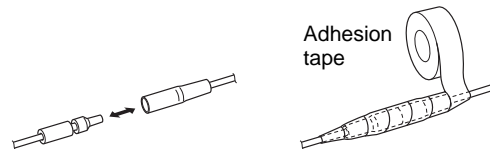

9 CONNECTIONS AND MAINTENANCE

■ Mounting the transceiver

Using the supplied mounting bracket

The universal mounting bracket supplied with your transceiver allows overhead or dashboard mounting.

- Mount the transceiver securely with the 2 supplied screws (M5 × 20) to a surface which is more than 10 mm thick and can support more than 5 kg.
- Mount the transceiver so that the face of the transceiver is at 90° to your line of sight when operating it.

/// **CAUTION: KEEP** the transceiver and microphone at least 1 meter away from your vessel's magnetic navigation compass.

/// **NOTE:** Check the installation angle; the function display may not be easy-to-read at some angles.

• OVERHEAD MOUNTING

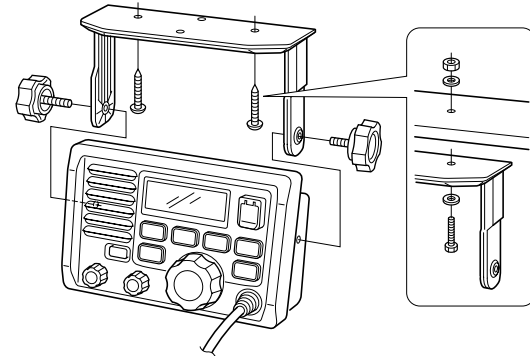

• MOUNTING ON DASHBOARD

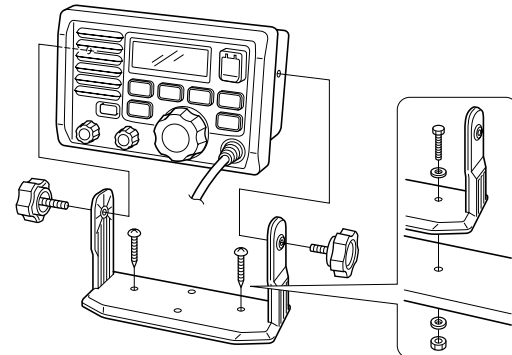

Using the optional mounting bracket

An optional MB-75 FLUSH MOUNT is available for mounting the transceiver to a flat surface such as an instrument panel.

CAUTION: KEEP the transceiver and microphone at least 1 meter away from your vessel's magnetic navigation compass.

- ① Using the template on the last page, carefully cut a hole into the instrument panel (or wherever you plan to mount the controller).
- ② Slide the transceiver through the hole as shown below.

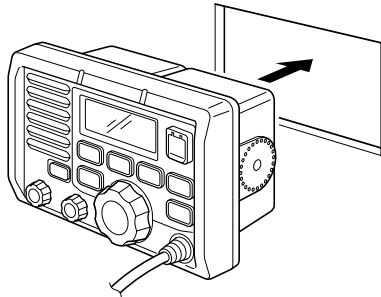

- ③ Attach the 2 supplied bolts (M5 × 8 mm) on either side of the IC-M502.

- ④ Attach the clamps on either side of the IC-M502.
 - Make sure that the clamps align parallel to the IC-M502's body.

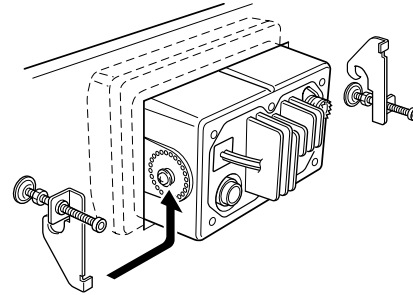

- ⑤ Tighten the end bolts on the clamps (rotate clockwise) so that the clamps press firmly against the inside of the instrument control panel.
- ⑥ Tighten the locking nuts (rotate counterclockwise) so that the IC-M502 is securely mounted in position as below.
- ⑦ Connect the antenna and control cable, then return the instrument control panel to its original place.

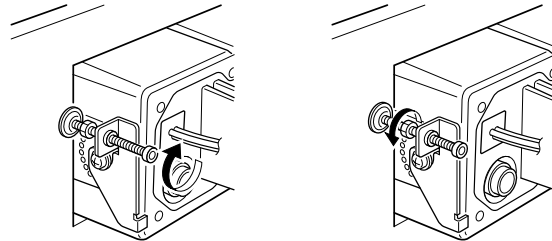

■ Optional unit installation

CAUTION: DISCONNECT the DC power cable from the transceiver before performing any work on the transceiver. Otherwise, there is danger of electric shock and/or equipment damage.

Follow the case opening procedure shown here when you want to install an optional unit, etc.

- ① Remove the 6 screws as shown below and open the transceiver.

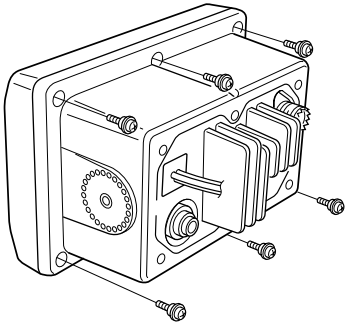

- ② Remove the 4 screws from the shielding plate, then lift up the shielding plate.
- ③ Plug an optional unit to J6 on the MAIN unit as shown below.

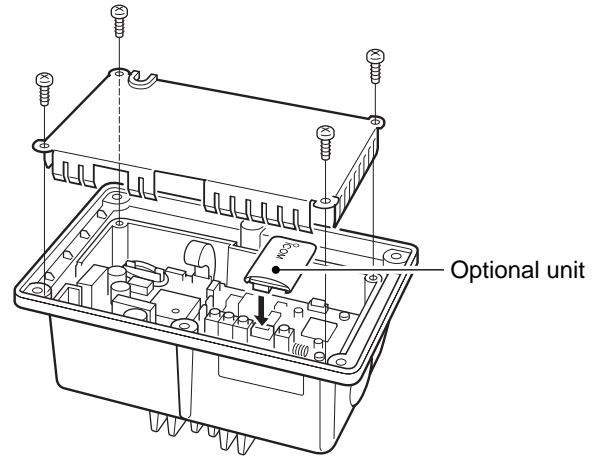

- ④ Return the shielding plate and assemble the units to their original positions.

■ Dimensions

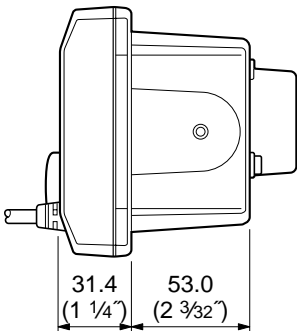
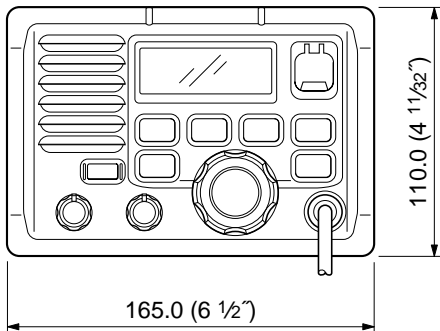
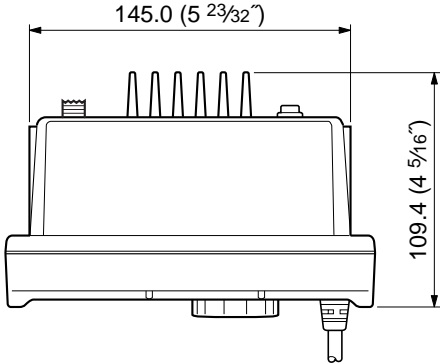

Unit: mm (inch)

10 TROUBLESHOOTING

PROBLEM	POSSIBLE CAUSE	SOLUTION	REF.
No power comes ON.	<ul style="list-style-type: none"> •Bad connection to the power supply. 	<ul style="list-style-type: none"> •Check the connection to the transceiver. 	p. 35
No sound comes from the speaker.	<ul style="list-style-type: none"> •Squelch level is too deep. •Volume level is too low. •Speaker has been exposed to water. •Internal speaker is turned OFF. 	<ul style="list-style-type: none"> •Set squelch to the threshold point. •Set [VOL] to a suitable level. •Drain water from the speaker. •Turn the internal speaker ON in set mode. 	<p>p. 8</p> <p>p. 8</p> <p>—</p> <p>p. 32</p>
Sensitivity is low.	<ul style="list-style-type: none"> •The attenuator is activated. 	<ul style="list-style-type: none"> •Push [LO/DX] to turn the function OFF. 	p. 8
Transmitting is impossible, or high power cannot be selected.	<ul style="list-style-type: none"> •Some channels are for low power or receive only. •The output power is set to low. 	<ul style="list-style-type: none"> •Change channels. •Push [HI/LO] to select high power. 	<p>pgs. 6, 41</p> <p>p. 8</p>
Scan does not start.	<ul style="list-style-type: none"> •“TAG” channel is not programmed. 	<ul style="list-style-type: none"> •Set the desired channels as “TAG” channels. 	p. 13
No beep sounds.	<ul style="list-style-type: none"> •Beep tone is turned OFF. •The squelch is open. 	<ul style="list-style-type: none"> •Turn the beep tone ON in set mode. •Set squelch to the threshold point. 	<p>p. 32</p> <p>p. 8</p>
Receive signal cannot be understood.	<ul style="list-style-type: none"> •Optional voice scrambler is turned OFF. •Scramble code is not set correctly. 	<ul style="list-style-type: none"> •Turn the optional voice scrambler ON. •Reset the scramble code. 	<p>p. 10</p> <p>p. 33</p>
Distress call cannot be transmitted.	<ul style="list-style-type: none"> •MMSI (DSC self ID) code is not programmed. 	<ul style="list-style-type: none"> •Program the MMSI (DSC self ID) code. 	p. 14

CHANNEL LIST 11

Channel number			Frequency (MHz)	
USA	INT	CAN	Transmit	Receive
	01	01	156.050	160.650
01A			156.050	156.050
	02	02	156.100	160.700
	03	03	156.150	160.750
03A			156.150	156.150
	04		156.200	160.800
		04A	156.200	156.200
	05		156.250	160.850
05A		05A	156.250	156.250
06	06	06	156.300	156.300
	07		156.350	160.950
07A		07A	156.350	156.350
08	08	08	156.400	156.400
09	09	09	156.450	156.450
10	10	10	156.500	156.500
11	11	11	156.550	156.550
12	12	12	156.600	156.600
13 [†]	13	13 [†]	156.650	156.650
14	14	14	156.700	156.700
15 [†]	15 [†]	15 [†]	156.750	156.750
16	16	16	156.800	156.800
17 [†]	17	17 [†]	156.850	156.850
	18		156.900	161.500
18A		18A	156.900	156.900
	19		156.950	161.550

Channel number			Frequency (MHz)	
USA	INT	CAN	Transmit	Receive
19A		19A	156.950	156.950
20	20	20 [†]	157.000	161.600
20A			157.000	157.000
	21	21	157.050	161.650
21A		21A	157.050	157.050
		21b	Rx only	161.650
	22		157.100	161.700
22A		22A	157.100	157.100
	23	23	157.150	161.750
23A			157.150	157.150
24	24	24	157.200	161.800
25	25	25	157.250	161.850
		25b	Rx only	161.850
26	26	26	157.300	161.900
27	27	27	157.350	161.950
28	28	28	157.400	162.000
		28b	Rx only	162.000
	60	60	156.025	160.625
	61		156.075	160.675
61A		61A	156.075	156.075
	62		156.125	160.725
		62A	156.125	156.125
	63		156.175	160.775
63A			156.175	156.175
	64	64	156.225	160.825

Channel number			Frequency (MHz)	
USA	INT	CAN	Transmit	Receive
64A		64A	156.225	156.225
	65		156.275	160.875
65A	65A	65A	156.275	156.275
	66		156.325	160.925
66A	66A	66A [†]	156.325	156.325
67 [†]	67	67	156.375	156.375
68	68	68	156.425	156.425
69	69	69	156.475	156.475
70 [†]	70 [†]	70 [†]	156.525	156.525
71	71	71	156.575	156.575
72	72	72	156.625	156.625
73	73	73	156.675	156.675
74	74	74	156.725	156.725
77 [†]	77	77 [†]	156.875	156.875
	78		156.925	161.525
78A		78A	156.925	156.925
	79		156.975	161.575
79A		79A	156.975	156.975
	80		157.025	161.625
80A		80A	157.025	157.025
	81		157.075	161.675
81A		81A	157.075	157.075
	82		157.125	161.725
82A		82A	157.125	157.125
	83	83	157.175	161.775

Channel number			Frequency (MHz)	
USA	INT	CAN	Transmit	Receive
83A		83A	157.175	157.175
		83b	Rx only	161.775
84	84	84	157.225	161.825
84A			157.225	157.225
85	85	85	157.275	161.875
85A			157.275	157.275
86	86	86	157.325	161.925
86A			157.325	157.325
87	87	87	157.375	161.975
87A			157.375	157.375
88	88	88	157.425	162.025
88A			157.425	157.425
WX channel	Frequency (MHz)			
	Transmit	Receive		
1	RX only	162.550		
2	RX only	162.400		
3	RX only	162.475		
4	RX only	162.425		
5	RX only	162.450		
6	RX only	162.500		
7	RX only	162.525		
8	RX only	161.650		
9	RX only	161.775		
10	RX only	163.275		

[†]Low power only. [‡]Receive only.

NOTE: Simplex channels, 3, 21, 23, 61, 64, 81, 82 and 83 **CANNOT** be lawfully used by the general public in U.S.A. waters.

12 SPECIFICATIONS AND OPTIONS

■ Specifications

General

- Frequency coverage :
 - Transmit 156.025–157.425 MHz
 - Receive 156.050–163.275 MHz
- Mode : FM (16K0G3E)
DSC (16K0G2B)
- Channel spacing : 25 kHz
- Current drain (at 13.8 V) : TX high 6.0 A max.
Max. audio 1.2 A max.
- Power supply requirement: 13.8 V DC \pm 15%
- Frequency stability : \pm 10 ppm
(-20°C to $+60^{\circ}\text{C}$; -4°F to $+140^{\circ}\text{F}$)
- Dimensions : 165(W) \times 110(H) \times 109.4(D) mm
(Projection not included) 6 $\frac{1}{2}$ (W) \times 4 $\frac{11}{32}$ (H) \times 4 $\frac{5}{16}$ (D) in
- Weight : 1130 g; 2 lb 8 oz

Transmitter

- Output power : 25 W and 1 W
- Modulation system : Variable reactance phase modulation
- Max. frequency deviation : \pm 5.0 kHz
- Spurious emissions : -70 dB

Receiver

- Receive system : Double conversion superheterodyne
- Sensitivity (12 dB SINAD) : Less than 0.25 μV (typical)
- Squelch sensitivity : Less than 0.3 μV
- Intermodulation rejection ratio: More than 80 dB (typical)
- Spurious response rejection ratio : More than 80 dB (typical)
- Adjacent channel selectivity: More than 80 dB (typical)
- Audio output power : More than 3.5 W at 10% distortion with a 4 Ω load

All stated specifications are subject to change without notice or obligation.

■ Options

•MB-75 FLUSH MOUNT

For mounting the transceiver to a panel.

•SP-5 EXTERNAL SPEAKER

A large, external speaker for superior audio output.

•SP-10 EXTERNAL SPEAKER

A compact, external speaker. Features easy installation.

•UT-98 VOICE SCRAMBLER UNIT (pgs. 10, 33)

•UT-112 VOICE SCRAMBLER UNIT

Ensures private communications. 128 or 32 codes are available. Not available in some countries.

•HM-127 REMOTE-CONTROL MICROPHONE (p. 44)

External microphone-type controller. Provides optional intercom operation. 6 m (20 feet) microphone cable and mounting base included. Black and white colors are available.

•OPC-999 MICROPHONE EXTENSION CABLE

6 m (20 feet) microphone extension cable for optional HM-127. Up to 2 OPC-999 can be connected. (18 m; 60 feet maximum)

■ Panel description

The optional HM-127 remotely controls the IC-M502 and provides an optional intercom function.

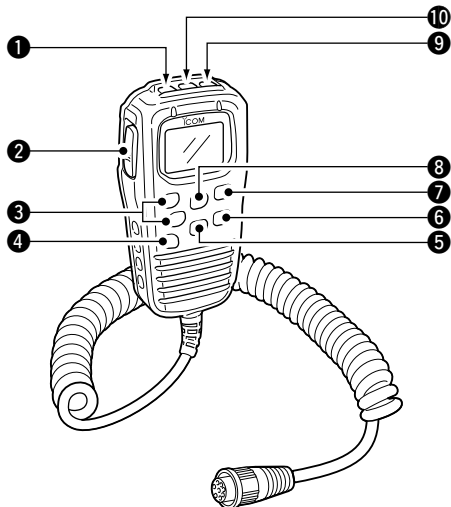

❶ POWER SWITCH [PWR] (pgs. 8, 51)

Push for 2 sec. to turn the HM-127 power ON or OFF when the IC-M502 power is turned ON.

❷ PTT SWITCH [PTT] (pgs. 8, 51)

Push and hold to transmit; release to receive.

❸ CHANNEL UP/DOWN SWITCHES [▲]/[▼]

- Push either switch to change the operating channel, set mode contents, etc. (pgs. 8, 51)
- While pushing [H/L], push [▲]/[▼] to adjust the brightness of the LCD and switch backlight. (p. 52)
- Push either switch to adjust audio level or noise squelch level after [VOL] or [SQL] is pushed, respectively. (pgs. 8, 51)
- In set mode, changes setting of the selected item. (pgs. 9, 55)
- Checks tag channels or changes scanning direction during scan. (pgs. 8, 54)

❹ CHANNEL 16/CALL CHANNEL SWITCH [16•9]

- Selects channel 16 when pushed. (pgs. 6, 50)
- Selects call channel when pushed for 1 sec. (pgs. 6, 50)
 - “CALL” appears when call channel is selected.
- Push for 3 sec. to enter call channel programming condition when call channel is selected. (pgs. 9, 53)
- While pushing [H/L], enters memory name programming condition. (pgs. 9, 56)
- Enters set mode when pushed while turning power ON. (pgs. 30, 55)

❺ CHANNEL/DUALWATCH/TRI-WATCH SWITCH [CH/WX•DW•U//C]

- Selects and toggles the regular channels and weather channel when pushed momentarily. (pgs. 6, 7, 50)

➔ While pushing [H/L], selects one of 3 regular channels in sequence when pushed. (pgs. 6, 7, 50)

- International, U.S.A. and Canadian channels are available for regular channels.

➔ Starts dualwatch or tri-watch when pushed for 1 sec. (pgs. 11, 54)

➔ Stops dualwatch or tri-watch when either is activated.

6 ATTENUATOR/INTERCOM/SCRAMBLER SWITCH [LO/DX•IC•SCR]

➔ Toggles the attenuator function ON and OFF when pushed momentarily. (pgs. 8, 51)

- “LOCAL” appears when the attenuator is in use.

➔ Activates the intercom function when pushed for 1 sec. (pgs. 29, 56)

➔ Calls the IC-M502 when pushed and held while in intercom mode. (pgs. 29, 56)

➔ While pushing [H/L], activates an optional voice scrambler function. (pgs. 10, 53)

- The optional voice scrambler function cannot be used on channel 16 and 70.

7 SQUELCH/MONITOR/LOCK SWITCH [SQL•MONI•L]

➔ [▲]/[▼] sets the squelch threshold level after pushing [SQL]. (p. 51)

➔ Push [SQL•MONI] for 1 sec. to turn the monitor function ON. (p. 52)

➔ While pushing [H/L], push [SQL•MONI•L] to toggle the microphone key lock function ON or OFF. (p. 52)

- “” appears while key lock function is in use.

- [PWR], [PTT], [VOL], [SQL] and [H/L] still function when the microphone key lock function is turned ON.

➔ Advance the cursor while in memory name programming condition. (pgs. 9, 56)

8 VOLUME/DIMMER SWITCH [VOL•DIM]

➔ [▲]/[▼] adjusts the audio level after pushing [VOL].

➔ Push [VOL•DIM] for 1 sec. to adjust the brightness of the LCD and switch backlight. (p. 52)

➔ Move the cursor backward while in memory name programming condition. (pgs. 9, 56)

9 TRANSMIT POWER SWITCH [H/L]

➔ Toggles high and low power when pushed. (pgs. 8, 51)

- Some channels are set to low power only.

➔ While pushing this switch, other switches perform secondary functions.

➔ Toggles the all key lock function ON or OFF when pushed while turning power ON. (p. 52)

- “” flashes while the all key lock function is in use.
- Only [PWR] and [PTT] function when the all key lock function is in use.

10 SCAN SWITCH [SCN•TAG] (pgs. 13, 54)

➔ Starts and stops normal or priority scan when tag channels are programmed.

➔ Push [SCN•TAG] for 1 sec. to set the displayed channel as a tag (scanned) channel.

➔ While pushing [H/L], push for 3 sec. to clear all tag channels.

■ Function display

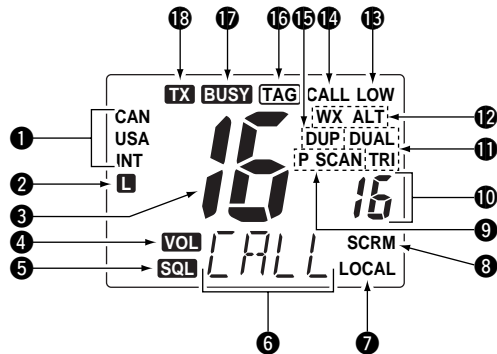

- 1 CHANNEL GROUP INDICATOR** (pgs. 6, 50)
Indicates whether an International (INT), U.S.A. (USA) or Canadian (CAN) channel is selected.
- 2 KEY LOCK INDICATOR** (p. 52)
 - Appears while the key lock function is in use.
 - Flashes while the all key lock function is in use.
- 3 CHANNEL NUMBER READOUT**
 - Indicates the selected operating channel number. "A" appears when a simplex channel is selected. (pgs. 6, 50)

- In set mode, indicates the selected condition. (pgs. 30, 55)

- 4 VOLUME INDICATOR** (p. 51)
Appears while audio output level is adjusted.
- 5 SQUELCH INDICATOR** (p. 51)
Appears while noise squelch level is adjusted.
- 6 CHANNEL NAME INDICATOR**
 - Channel comment appears (and scrolls) if programmed. (pgs. 9, 56)
 - In set mode, indicates or scrolls the selected set mode item. (pgs. 30, 55)
- 7 ATTENUATOR INDICATOR** (pgs. 8, 51)
Appears when the RF attenuator is in use.
- 8 SCRAMBLER INDICATOR** (pgs. 10, 53)
Appears when an optional voice scrambler is activated.
- 9 SCAN INDICATOR** (pgs. 13, 54)
 - "SCAN" appears during normal scan.
 - "P SCAN" appears during priority scan.
- 10 PRIORITY CHANNEL INDICATOR**
 - Indicates a priority channel during priority scan or dual/tri-watch. (pgs. 12, 54)
 - "IC" appears during intercom mode. (pgs. 29, 56)

- ① **DUAL/TRI WATCH INDICATOR** (pgs. 11, 54)
 “DUAL” appears during dualwatch; “TRI” during tri-watch.
- ② **WEATHER CHANNEL INDICATOR** (pgs. 7, 50)
 - ↳ “WX” appears when a weather channel is selected.
 - ↳ “ALT” appears when the weather alert function is in use; flashes when an alert tone is received.
- ③ **LOW POWER INDICATOR** (pgs. 8, 51)
 Appears when low power is selected.
- ④ **CALL CHANNEL INDICATOR** (pgs. 6, 50)
 Appears when the call channel is selected.
- ⑤ **DUPLEX INDICATOR** (pgs. 6, 50)
 Appears when a duplex channel is selected.
- ⑥ **TAG CHANNEL INDICATOR** (pgs. 13, 54)
 Appears when a tag channel is selected.
- ⑦ **BUSY INDICATOR** (pgs. 8, 51, 52)
 Appears when receiving a signal or when the squelch opens.
- ⑧ **TRANSMIT INDICATOR** (pgs. 8, 51)
 Appears while transmitting.

■ HM-127 supplied accessories

Accessories included with the HM-127:	Qty.
① Connection cable (OPC-1000: 6 m; 20 ft)	1
② Mounting base	1
③ Microphone hanger	1
④ Screws (M3 × 16; tapping)	5

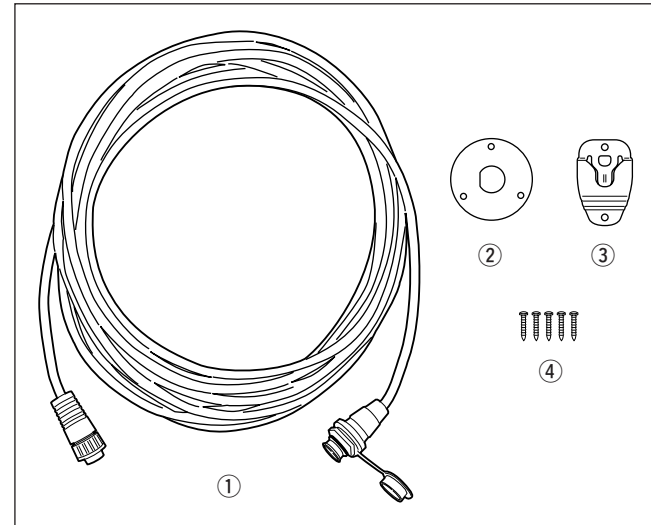

13 HM-127 REMOTE-CONTROL MICROPHONE

■ Installation

The optional HM-127 can be connected to the transceiver directly, as well as via the supplied connection cable for longer distance remote operation. The connector of the connection cable can be installed into a cabinet, wall, etc., as a built-in plug.

For longer distance remote operation, the optional extension cable, OPC-999 (6 m; 20 ft/Connecting between transceiver and the connection cable.), is available, and up to 2 OPC-999 can be added.

- ① Insert the supplied cable into the external microphone jack and tighten the cable nut as shown below.

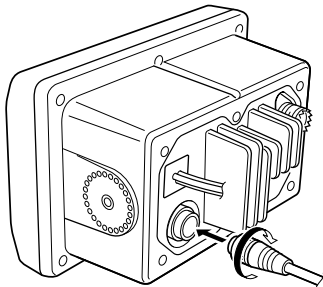

- ② To use the supplied cable as a wall socket, follow the following steps.
- ③ Using the mounting base, carefully mark off the 2 spots where the cable and screws will be fastened.
- ④ Drill holes at these marks.
- ⑤ Install the mounting base using screws as shown below.

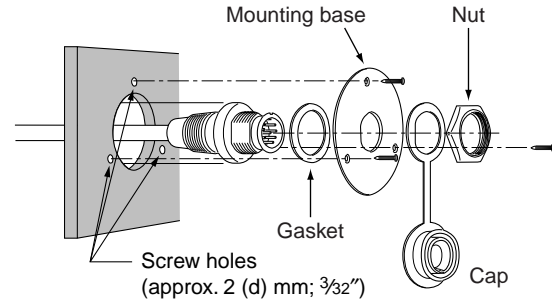

- ⑥ The installation is finished when it is completed.

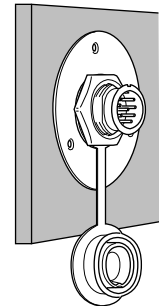

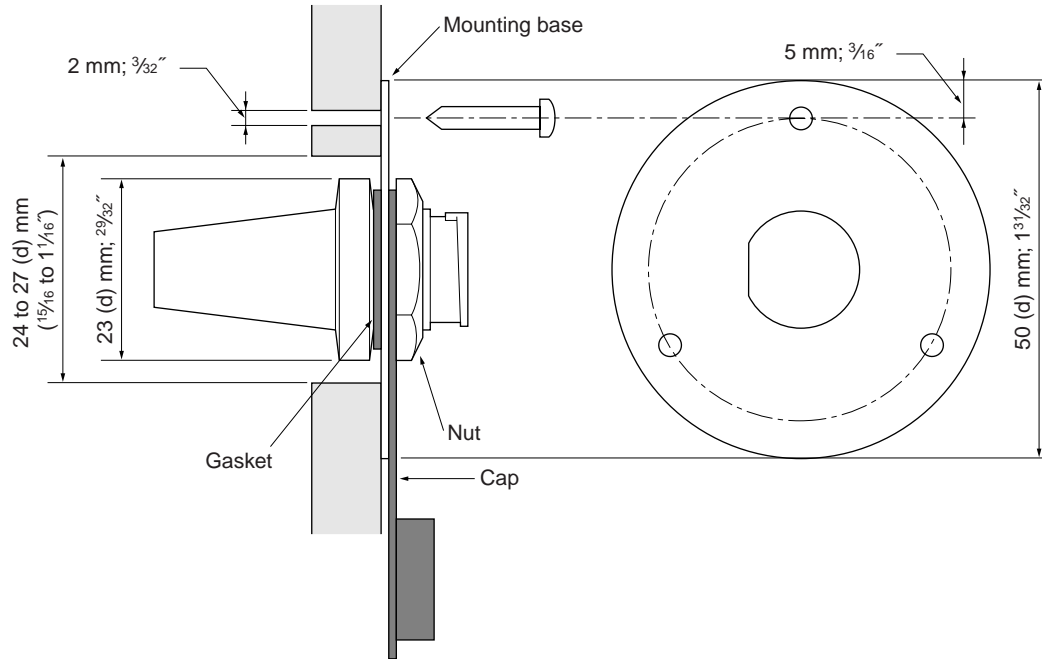

■ Channel selection

Channel 16

- ① Push [16] to select channel 16.
- ② Push [CH/WX] to return to the condition before selecting channel 16, or push [▲] or [▼] to select operating channel.

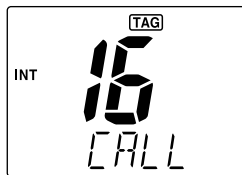

Push 

Call channel

- ① Push [16•9] for 1 sec. to select call channel.
- ② Push [CH/WX] to return to the condition before selecting call channel, or push [▲] or [▼] to select operating channel.



Push  9 for 1 sec.

Weather channels

- ① Push [CH/WX] once or twice to select weather channel group.
- ② Push [▲] or [▼] to select weather channel.
- ③ Push [CH/WX] to return to the condition before selecting the weather channel group.

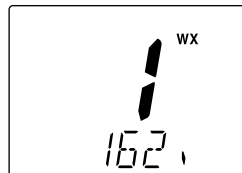

Push 

U.S.A., International and Canadian channels

- ① Push [CH/WX] to select regular channel.
 - Push [CH/WX] again, if weather channel appears.
- ② Push [CH/WX•U/I/C], while pushing [H/L], to select channel group.
 - U.S.A., International and Canadian channels can be selected in sequence.

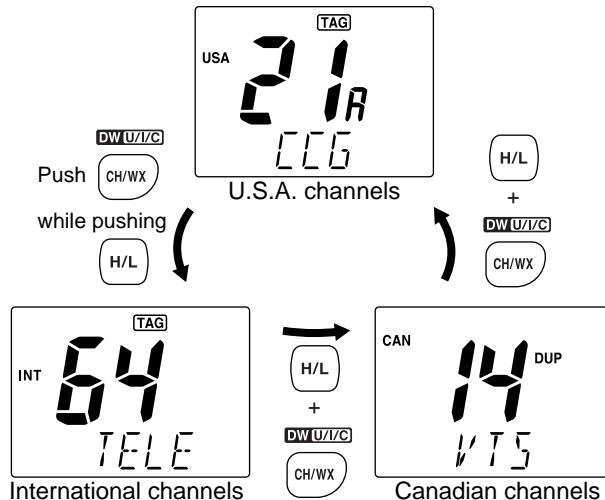

■ Receiving and transmitting

- ① Push [PWR] to turn power ON.
- ② Push [VOL], then [▲]/[▼] to adjust audio output level.
 - Push [SQL], then [▲]/[▼] to mute any audio noise, if necessary.
- ③ Push [▲]/[▼] to select the desired channel.
 - When receiving a signal, “**BUSY**” appears and audio is emitted from the speaker.
 - Further adjustment of audio level may be necessary at this point.
 - Use the optional voice scrambler function for privacy. (pgs. 10, 53)
- ④ Push [H/L] to select the output power, if necessary.
 - “**LOW**” appears when low power is selected.
 - Choose low power for shorter, high power for longer distance communications.
 - Some channels are low power only.

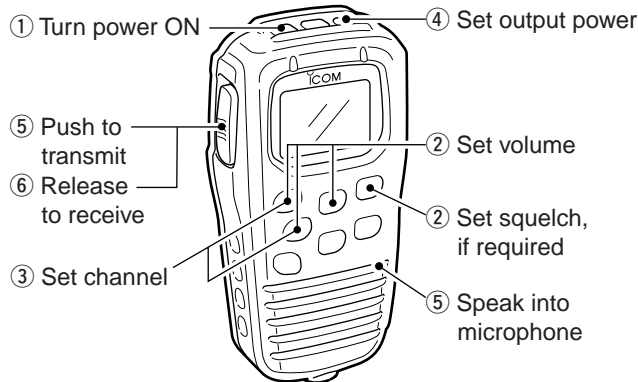

- ⑤ Push and hold [PTT] to transmit, then speak into the microphone.
 - “**TX**” appears.
 - Channel 70 cannot be used for transmission (for GMDSS use).

Simplex channels, 3, 21, 23, 61, 64, 81, 82 and 83 **CAN-NOT** be lawfully used by the general public in U.S.A. waters.

- ⑥ Release [PTT] to receive.

IMPORTANT: To maximize the readability of your transmitted signal (voice), pause a few sec. after pushing [PTT], hold the microphone 10 to 15 cm (4 to 6 inches) from your mouth and speak at a normal voice level.

■ RF attenuator function

- ➔ Push [LO/DX] to turn the RF attenuator function ON and OFF.



Appears when the RF attenuator function is in use

■ Lock functions

The lock function electronically locks keys and switches to prevent accidental changes and function access from the microphone.

- All keys, switches and controllers on the transceiver are functional.

Activating the lock function

➔ Push [SQL] while pushing [H/L] to turn the lock function ON and OFF.

- “**L**” appears.
- Only [PWR], [PTT], [H/L], [SQL•MONI], [VOL]+[▲]/[▼] and [SQL]+[▲]/[▼] are functional.



Appears when the lock function is in use.

Activating the all key lock function

➔ Turn the power ON by pushing [PWR] while pushing [H/L] to turn the all key lock function ON and OFF.

- “**L**” flashes.
- Only [PWR] and [PTT] are functional.



Flashes when the all lock function is in use.

■ Display backlighting

The function display and switches can be backlit for better visibility under low light conditions. And the backlighting condition can be adjusted independently from the transceiver.

- ① Push [VOL•DIM] for 1 sec. to enter backlight adjusting mode.
 - “**DIM**” with number of backlight level appears in the channel name indicator.
- ② Push [▲]/[▼] to adjust the backlight level.
 - The backlight level is adjustable between 0 (lights OFF) and 7 (brightest).

For your reference:

Pushing [▲]/[▼], while [H/L] is pushed, also adjusts backlight level.

- No backlight level indication is available.

■ Monitor function

The monitor function releases the noise squelch mute of the microphone only. (An independent noise squelch system is employed.)

- ➔ Push [SQL•MONI] for 1 sec. to activate the monitor function.
- “**BUSY**” flashes and audio is emitted.
 - Any key, except [▲]/[▼], cancels the monitor function.

■ Call channel programming

- ① Push [CH/WX•U/I/C] several times while pushing [H/L] to select the desired channel group (USA, INT, CAN) to be programmed.
- ② Push [16•9] for 1 sec. to select the call channel of the selected channel group.
 - “CALL” and call channel number appear.
- ③ Push [16•9] again for 3 sec. (until long beep changes to 2 short beeps) to enter call channel programming condition.
 - Call channel number and channel group to be programmed flashes.
- ④ Push [▲]/[▼] to select the desired channel.
- ⑤ Push [16•9] to program the displayed channel as the call channel.
 - The call number and channel group stop flashing.

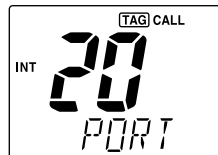
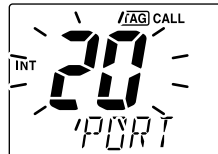
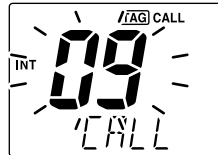
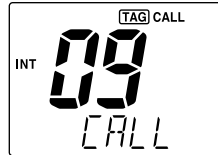

■ Optional voice scrambler operation

Activating the scrambler

- ① Select an operating channel, except channel 16 or weather channels.
- ② Push [LO/DX•IC•SCR] while pushing [H/L] to turn the voice scrambler function ON.
 - “SCRM” appears.
- ③ To turn the scrambler function OFF, repeat step ②.
 - “SCRM” disappears.

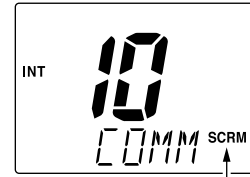

Appears when the voice scrambler function is in use.

Programming scramble codes

There are 128 codes (00 to 127) available with UT-98 or 32 codes (01 to 32) available with the UT-112 for programming. In order to understand one another, all transceivers in your group must have the same scrambler code, as well as the same scrambler unit. The scrambler code is programmed in set mode. See pgs. 10, 33, 55 for details.

■ Starting a scan

- ① Push [CH/WX•U/I/C] several times while pushing [H/L] to select the channel group (USA, INT, CAN), if desired.
 - When the weather alert function is in use, select the desired weather channel with [CH/WX] and [▲]/[▼].
- ② Push [SCN] to start priority or normal scan.
 - “SCAN” appears during normal scan.
 - The priority channel readout indicates “16”, and “P” and “SCAN” indicators appear during priority scan.
 - When a signal is received, scan pauses until the signal disappears or resumes after pausing 5 sec. according to set mode setting (Channel 16 is still monitored during priority scan).
 - Push [▲]/[▼] to check the scanning tag channels, to change the scanning direction or resume the scan manually.
- ③ To stop the scan, push [SCN].
 - “SCAN” disappears.
 - Pushing [PTT], [16•9] or [CH/WX] also stops the scan.

■ Setting tag channels

- ① Push [CH/WX•U/I/C] several times while pushing [H/L] to select the channel group (USA, INT, CAN), if desired.
- ② Push [▲]/[▼] to select the desired channel to set as a tag channel.
- ③ Push [SCN•TAG] for 1 sec. to set the displayed channel as a tag channel.
 - “TAG” appears.
- ④ To cancel the tag channel setting, push [SCN•TAG] for 1 sec.
 - “TAG” disappears.

•Clearing all tag channels in the selected channel group

- ➔ Push [SCN•TAG] while pushing [H/L] for 3 sec. (until long beep changes to 2 short beeps).

■ Dualwatch/Tri-watch operation

- ① Push [▲]/[▼] to select the desired channel.
 - Push [CH/WX•U/I/C] several times while pushing [H/L] to select the channel group (USA, INT, CAN), if desired.
- ② Push [CH/WX•DW] for 1 sec. to start dualwatch or tri-watch.
 - “DUAL” appears during dualwatch; “TRI” appears during tri-watch.
 - Beep tone sounds when a signal is received on channel 16.
 - Tri-watch becomes dualwatch when receiving a signal on the call channel.
- ③ To cancel dualwatch/tri-watch, push [CH/WX•DW] again.

■ Set mode programming

Set mode is used to change the condition of the transceiver's functions and the microphone's own functions:

Transceiver's functions—

scan mode (normal or priority), scan resume timer, weather alert, dualwatch/tri-watch selection, DSC watch, transceiver's beep tone, internal speaker (transceiver), LCD contrast (transceiver), RF attenuation level, scrambler code and scrambler type.

Microphone's own functions—

beep tone function (microphone) and LCD contrast (microphone).

In this section, instructions are for the microphone's own functions only. Refer pgs. 30–33 for the setting of the other functions. (Some functions may not be selected from the microphone.)

Entering set mode

- ① Turn power OFF.
- ② While pushing [16•9], turn power ON.
 - After beep emission, a set mode item (in the channel name indicator and condition in the channel number readout) is displayed.
- ③ Push [16•9] to select the desired item, if necessary.
- ④ Push [▲]/[▼] to select the desired condition of the item.
- ⑤ Turn power OFF, then ON to exit set mode.

• Beep tone “BEEP”

→ Push [▲] to turn ON, [▼] to turn OFF the beep output.

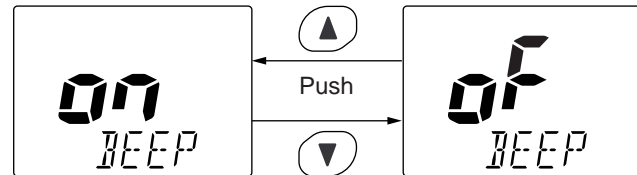

• LCD contrast “LCD CONTRAST”

→ Push [▲]/[▼] to adjust to a suitable LCD contrast.

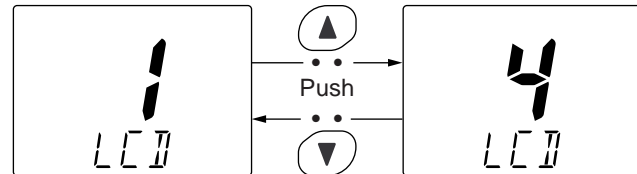

■ Intercom operation

- ① Push [LO/DX•IC] for 1 sec. to activate the intercom function.
 - “IC” appears in the priority channel readout.
 - The channel name disappears.
- ② Push [PTT] to talk.
 - “*TALK*” appears in the channel name indicator.
- ③ Release [PTT] to listen.
 - “*LSTN*” appears in the channel name indicator when the transceiver is in talking.
- ④ Push [LO/DX•IC] to cancel the intercom function.
 - Pushing [16], [SCN•TAG] or [CH/WX] is also cancels the intercom function.

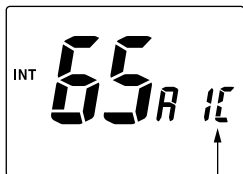

Appears when the intercom function is in use.

For your reference:

In case the intercom mode is selected with the transceiver during microphone power OFF, the microphone power is automatically turned ON and the intercom mode is selected.

Intercom beep function

- ➔ Push [LO/DX•IC] for more than 1 sec.
 - Emits intercom beep while holding.

■ Channel names

- ① Push [▲]/[▼] to select a channel to program.
 - Push [CH/WX•U/I/C] several times while pushing [H/L] to select the channel group (USA, INT, CAN), if desired.
- ② While pushing [H/L], push [16•9].
 - The 1st character of the currently programmed comment flashes.
- ③ Push [▲]/[▼] to select a character.
- ④ Push [SQL] to move to right; then push [▲]/[▼] to select a character.
 - Push [VOL] to move to the left.
- ⑤ Continue until the desired characters have been selected, the push [16•9] to return to normal operation.

• Available characters

(space)	! (!)	" (")	# (#)	\$ (\$)	% (%)	& (&)	' (')	((())) ())
* (*)	+ (+)	, (,)	-- (-)	\ (.)	/ (/)	0 (0)	1 (1)	2 (2)	3 (3)
4 (4)	5 (5)	6 (6)	7 (7)	8 (8)	9 (9)	A (A)	B (B)	C (C)	D (D)
E (E)	F (F)	G (G)	H (H)	I (I)	J (J)	K (K)	L (L)	M (M)	N (N)
O (O)	P (P)	Q (Q)	R (R)	S (S)	T (T)	U (U)	V (V)	W (W)	X (X)
Y (Y)	Z (Z)	a (a)	b (b)	c (c)	d (d)	e (e)	f (f)	g (g)	h (h)
i (i)	j (j)	k (k)	l (l)	m (m)	n (n)	o (o)	p (p)	q (q)	r (r)
s (s)	t (t)	u (u)	v (v)	w (w)	x (x)	y (y)	z (z)		

TEMPLATE

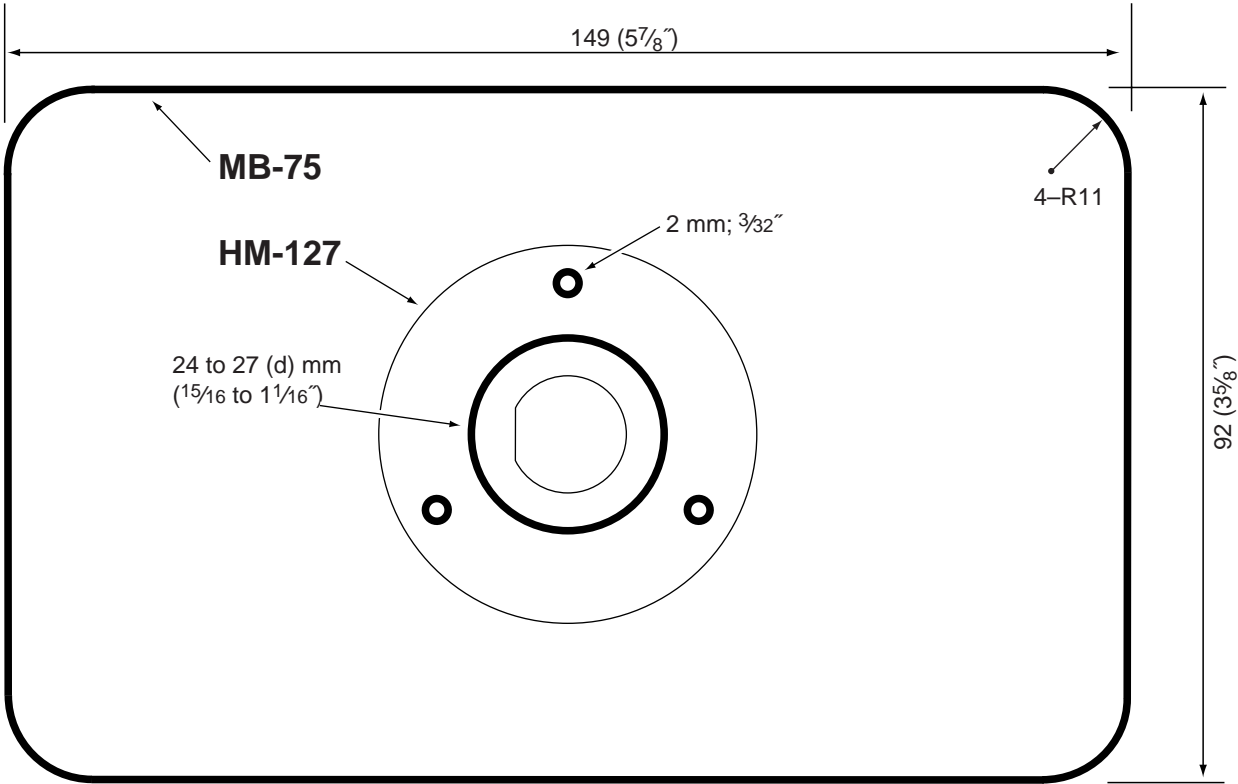

Cut here

Unit: mm (inch)

Count on us!

A-5663H-1EX-②
Printed in Japan
© 2000 Icom Inc.

Icom Inc.
1-1-32 Kamiminami, Hirano-ku, Osaka 547-0003 Japan